

A photograph of a cyclist wearing a blue helmet and a grey long-sleeved jersey, adjusting the helmet. The cyclist is wearing blue shorts and is sitting on a bicycle. The background is a blurred outdoor setting with dry grass and a clear sky. The image is framed by a white diagonal shape on the left and a blue diagonal shape on the right.

# THE RIGHT GEAR FOR EVERY RIDE

---

Make every ride the best it can be with specially built gear for every cycling adventure. From high-performance WheelSystems to components, apparel, accessories and service essentials, Giant is your one-stop source for quality gear made for rider and bike.

## GET READY TO RIDE

---



## RIDER GEAR

---

Gear for me.



## BIKE GEAR

---

Gear for my bike.

# GEAR ICON LEGEND

---

## INDIVIDUAL ICONS

---



**New** – This icon represents products that are new to the Giant Gear line-up



**Margin** – This icon represents products whereby the SRP is greater than keystone price, providing higher than typical margin. A complete list of prices is available on the Dealer Web Portal.



**Key** – This icon identifies one or more items that are essential within the segment. Individual key products are highlighted in Giant Blue or Liv Purple. Giant will attempt to keep stock all year round on these popular items to best serve retailers.

## RIDER GEAR ICONS

---



**Core** – Affordable but with an eye for detail, Core products fit the needs of riders wanting to feel comfortable all day long.



**Sport** – Well priced, and with performance in mind, Sport level products allow riders the advantages of technical fabrics, while keeping within budget.



**Performance** – The highest level in fabric quality, Performance products are designed with the greatest attention to detail, comfort and performance in mind.



**Pro Fit** – This icon represents apparel items that are fitted more aggressively than typical “Race Fit” products. As such, riders looking for a more relaxed fit should order accordingly.





# RIDER GEAR TECHNOLOGY

Equilibrium is the primary goal of any active sport oriented fabric – not too hot, not too cold. Next to the skin moisture management is key. In cooler conditions, wet heat conduction can rob the body of heat and leave the wearer uncomfortable. Conversely, on a hot day the same moisture is a barrier to heat release, which can lead to overheating. Giant Rider Gear features breathable antibacterial materials and chamois with multiple levels of protection for optimal weight distribution on the saddle and maximum comfort for all rider levels.

## FABRIC TECHNOLOGY

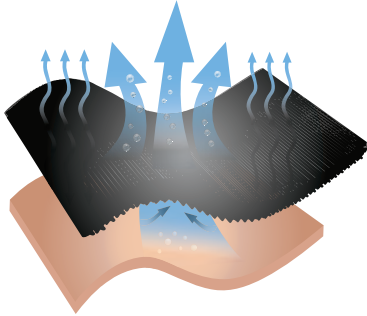

**TransTextura™**

### TransTextura™

Designed with denier gradient transfer technology, which uses larger diameter fibers next to the skin to pull moisture to the outer surface for evaporation and quick drying.

### TransTextura PLUS™

Enhanced moisture transfer technology allows quicker drying, and the addition of antimicrobial functionality neutralizes odors.



**ProTextura™**

### ProTextura™

Wind protection and durable water-repellent finishes and laminations are engineered to overcome wind, wet and rainy conditions. Features breathability to help your body regulate temperature.

### ProTextura PLUS™

Enhanced performance through the addition of dependable weather protective sealed seams provides truly waterproof construction.



**ThermTextura™**

### ThermTextura PLUS™

Builds on TransTextura™ with fleece on the backside of the fabric to add insulating air and protect you from the elements.

## CHAMOIS TECHNOLOGY



**ProComfor™**

1. Three perforated layers of foam constructed with a proprietary laminate bonding improves breathability compared to traditional bonding.
2. TransTextura Plus™ 4-way stretch fabric provides excellent moisture management and permanent anti-odor and antibacterial functions.
3. 11mm multi-thickness perforated high-density foam provides the ultimate support for long days in the saddle.



**SportComfor™**

1. Two perforated layers of foam and a special laminate construction improve breathability compared to traditional bonding.
2. TransTextura Plus™ 4-way stretch fabric provides excellent moisture management and permanent anti-odor and antibacterial functions.
3. 11mm multi-thickness perforated high-density foam provides the ultimate support for long days in the saddle.



**CoreComfor™**

1. TransTextura™ Plus 4-way stretch fabric provides excellent moisture management and permanent anti-odor and antibacterial functions.
2. 9mm high-density foam provides support without unwanted bulk.



# HELMET TECHNOLOGY

RACING, RIDING THROUGH CITY STREETS, OR BOMBING DOWN A TRAIL, YOUR HELMET IS YOUR MOST IMPORTANT ACCESSORY. GIANT'S NEW LINEUP OF HELMETS, INCLUDING THE HIGH-PERFORMANCE ROAD HELMET REV, FEATURES CUTTING-EDGE TECHNOLOGIES TO KEEP YOU COOL, COMFORTABLE AND SECURE.



## REV

### SUPER LIGHT, SUPER COMFORTABLE

With 21 ventilation ports, a fine-tuned CINCH+ fit system, and advanced materials construction, Rev gives you supreme comfort and weighs just 264 grams. Designed with LiteForm webbing and TransTextura Plus antimicrobial padding, it feels so light and flexible you'll forget you're wearing a helmet at all.

## TECHNOLOGY

### 1 INTERNAL STRUCTURAL SHELL

A continuous internal polycarbonate shell fuses the helmet structure together. The result is increased overall strength and toughness, and reduced overall weight.

### 2 IN-MOLD MICROSHELL/EPS CONSTRUCTION

The most advanced construction process is used to ensure consistent, seamless materials throughout the helmet for optimal protection and a flawless look. The in-mold microshell provides all-in-one construction for maximum structural integrity.

### 3 LITEFORM™ STRAP WEBBING

Using a special blend of thin, lightweight and tough woven material creates uncompromising strength and toughness, and reduced overall weight.

### 4 CINCH+™ FIT SYSTEM

The perfect blend of comfort and security, Cinch+ offers optimal coverage by cradling the occipital bone for full protection, support and comfort. Large scoop-like paddles protrude outward to cradle the cranium.

### 5 TRANSTEXTURA PLUS™ ANTIMICROBIAL, ANTI-ODOR PADDING

These highly advanced natural fabrics fight bacteria growth by pulling sweat from the rider's head and transferring it through exhaust ports in the 21-vent design. The natural property of the fabric inhibits microbes that cause odors.

# RIDER APPAREL



## RACE DAY SS JERSEY NEW

- Ti-Ex™ fabric is super soft with a titanium treatment
- Excellent wicking and durability
- High SPF
- Raglan sleeve cut
- Full height collar
- 3 rear pockets
- Elastic waist

Item	Size
850001231	XS
850001232	S
850001233	M
850001234	L
850001235	XL
850001236	2XL

Colour:  
BLUE/BLACK



\$129<sup>99</sup>



## RACE DAY LS JERSEY NEW

- Ti-Ex™ fabric is super soft with a titanium treatment
- Excellent wicking and durability
- High SPF
- Raglan sleeve cut
- Full height collar
- 3 rear pockets
- Elastic waist

Item	Size
850001237	XS
850001238	S
850001239	M
850001240	L
850001241	XL
850001242	2XL

Colour:  
BLUE/BLACK



\$159<sup>99</sup>



## RACE DAY BIB SHORT

- 4-way stretch Stratos™ fabric
- Chlorine resistant
- UPF, UVA and UVB transmission less than 0.1%
- Conformo™ chamois pad
- PowerBand™ Gel gripper leg closure
- Flatlock stitching

Item	Size
860000403	XS
860000404	S
860000405	M
860000406	L
860000407	XL
860000408	2XL

Colour:  
BLUE/BLACK



\$159<sup>99</sup>



## GIANT-SHIMANO TEAM SS JERSEY NEW

- Same jersey worn by the Giant-Shimano Pro Cycling Team
- Lightweight TransTextura fabric with full UV protection
- Unique fabric contains highly resistant fibers to protect against abrasion
- High degree of stretch, which gives it a comfortable, body hugging fit

- Printed panels are meticulously aligned so that all jerseys look identical, regardless of size
- Full-length zipper and three rear pockets

Item	Size
850001269	S
850001270	M
850001271	L
850001272	XL
850001273	2XL
850001274	3XL

\$209<sup>99</sup>



Colour:  
BLACK/WHITE

## RACE DAY SHORT NEW

- Clean and classic design
- E.I.T. Liege chamois
- High compression leg bands
- UPF 30+ sun protection

Item	Size
860000397	XS
860000398	S
860000399	M
860000400	L
860000401	XL
860000402	2XL

Colour:  
BLUE/BLACK



\$139<sup>99</sup>



## GIANT-SHIMANO CLIMBERS TEAM SS JERSEY



- Same jersey worn by the Giant-Shimano Pro Cycling Team
- Lightweight TransTextura fabric with full UV protection
- Vented panels for maximum breathability when climbing
- High degree of stretch, which gives it a comfortable, bodyhugging fit
- Printed panels are meticulously aligned so that all jerseys look identical, regardless of size
- Full-length zipper and three rear pockets

Item	Size
850001275	S
850001276	M
850001277	L
850001278	XL
850001279	2XL
850001280	3XL



Colour:  
BLACK/WHITE

\$219<sup>99</sup>

## GIANT-SHIMANO TEAM BIB SHORT



- Same bib shorts worn by Giant-Shimano Pro Cycling Team
- Silky fabric is smooth on skin yet provides good compression and breathability
- Exclusive leg gripper material gives perfect compression without feeling too tight and without using silicone grips that can irritate skin
- Urraki chamois ensures total freedom of movement, is antibacterial and very breathable

Item	Size
860000429	S
860000430	M
860000431	L
860000432	XL
860000433	2XL
860000434	3XL



\$249<sup>99</sup>

Colour:  
BLACK/WHITE

## REV PRO SS JERSEY



- Designed and created in partnership with Etxeondo
- TransTextura™ fabric provides permanent moisture transfer and sun protection to keep you comfortable
- Tone on tone print pattern on shoulders and main body accents

Item	Size	Colour
850001353	S	BLACK/WHITE
850001354	M	BLACK/WHITE
850001355	L	BLACK/WHITE
850001356	XL	BLACK/WHITE
850001357	2XL	BLACK/WHITE
850001358	3XL	BLACK/WHITE
850001359	S	BLACK/BLUE
850001360	M	BLACK/BLUE
850001361	L	BLACK/BLUE
850001362	XL	BLACK/BLUE
850001363	2XL	BLACK/BLUE
850001364	3XL	BLACK/BLUE



\$199<sup>99</sup>



## REV PRO BIB SHORT



- Designed and created in partnership with Etxeondo
- One piece laser cut bib straps
- Polyamide fabric is soft as cotton but durable for years of hard use
- Same E.I.T. as used by Giant Shimano Pro Team

Item	Size	Colour
860000519	S	BLACK/WHITE
860000520	M	BLACK/WHITE
860000521	L	BLACK/WHITE
860000522	XL	BLACK/WHITE
860000523	2XL	BLACK/WHITE
860000524	3XL	BLACK/WHITE
860000525	S	BLACK/BLUE
860000526	M	BLACK/BLUE
860000527	L	BLACK/BLUE
860000528	XL	BLACK/BLUE
860000529	2XL	BLACK/BLUE
860000530	3XL	BLACK/BLUE



\$249<sup>99</sup>



## STREAK SS JERSEY

- TransTextura™ fabric
- Full Length locking zipper
- Raglan sleeve cut
- Sweat proof phone pocket
- 3 rear pockets
- UPF 30+

Item	Size	Colour
850000596	XS	WHITE/BLACK/BLUE
850000597	S	WHITE/BLACK/BLUE
850000598	M	WHITE/BLACK/BLUE
850000599	L	WHITE/BLACK/BLUE
850000600	XL	WHITE/BLACK/BLUE
850000601	2XL	WHITE/BLACK/BLUE
850000608	XS	BLACK/BLUE
850000609	S	BLACK/BLUE
850000610	M	BLACK/BLUE
850000611	L	BLACK/BLUE
850000612	XL	BLACK/BLUE
850000613	2XL	BLACK/BLUE
850000590	XS	WHITE/GRAY/RED
850000591	S	WHITE/GRAY/RED
850000592	M	WHITE/GRAY/RED
850000593	L	WHITE/GRAY/RED
850000594	XL	WHITE/GRAY/RED
850000595	2XL	WHITE/GRAY/RED



\$79<sup>99</sup>



## STREAK LS JERSEY

- TransTextura™ fabric
- Full Length locking zipper
- Raglan sleeve cut
- Sweat proof phone pocket
- 3 rear pockets
- UPF 30+

Item	Size	Colour
850000614	XS	WHITE/GRAY/RED
850000615	S	WHITE/GRAY/RED
850000616	M	WHITE/GRAY/RED
850000617	L	WHITE/GRAY/RED
850000618	XL	WHITE/GRAY/RED
850000619	2XL	WHITE/GRAY/RED
850000620	XS	WHITE/BLACK/BLUE
850000621	S	WHITE/BLACK/BLUE
850000622	M	WHITE/BLACK/BLUE
850000623	L	WHITE/BLACK/BLUE
850000624	XL	WHITE/BLACK/BLUE
850000625	2XL	WHITE/BLACK/BLUE
850000632	XS	BLACK/BLUE
850000633	S	BLACK/BLUE
850000634	M	BLACK/BLUE
850000635	L	BLACK/BLUE
850000636	XL	BLACK/BLUE
850000637	2XL	BLACK/BLUE



\$89<sup>99</sup>



## TEAM 2.0 SS JERSEY

- TransTextura™ fabric
- Club fit
- Raglan sleeve cut
- Full-length zipper
- 3 rear pockets
- UPF 30+

Item	Size	Colour
850001413	XS	BLUE/BLACK
850001414	S	BLUE/BLACK
850001415	M	BLUE/BLACK
850001416	L	BLUE/BLACK
850001417	XL	BLUE/BLACK
850001418	2XL	BLUE/BLACK
850000370	XS	RED/BLACK
850000371	S	RED/BLACK
850000372	M	RED/BLACK
850000373	L	RED/BLACK
850000374	XL	RED/BLACK
850000375	2XL	RED/BLACK
850000948	XS	BLACK/WHITE
850000949	S	BLACK/WHITE
850000950	M	BLACK/WHITE
850000951	L	BLACK/WHITE
850000952	XL	BLACK/WHITE
850000953	2XL	BLACK/WHITE



\$59<sup>99</sup>



## TEAM 2.0 LS JERSEY

- TransTextura™ fabric
- Club fit
- Raglan sleeve cut
- Full-length zipper
- 3 rear pockets
- UPF 30+

Item	Size	Colour
850000376	XS	BLUE/BLACK
850000377	S	BLUE/BLACK
850000378	M	BLUE/BLACK
850000379	L	BLUE/BLACK
850000380	XL	BLUE/BLACK
850000381	2XL	BLUE/BLACK
850000382	XS	RED/BLACK
850000383	S	RED/BLACK
850000384	M	RED/BLACK
850000385	L	RED/BLACK
850000386	XL	RED/BLACK
850000387	2XL	RED/BLACK



\$64<sup>99</sup>



## TEAM SHORT

- Giant Team graphics
- CoreComfor™ Chamois
- Compression leg openings
- Seamless inner leg
- UPF 50
- Race fit

Item	Size	Colour
860000177	XS	BLACK/BLUE
860000178	S	BLACK/BLUE
860000179	M	BLACK/BLUE
860000180	L	BLACK/BLUE
860000181	XL	BLACK/BLUE
860000182	2XL	BLACK/BLUE
860000183	XS	BLACK/WHITE
860000184	S	BLACK/WHITE
860000185	M	BLACK/WHITE
860000186	L	BLACK/WHITE
860000187	XL	BLACK/WHITE
860000188	2XL	BLACK/WHITE



\$59<sup>99</sup>



## TEAM BIBSHORT

- Giant Team graphics
- CoreComfor™ Chamois
- Comfortable bib straps
- Compression leg openings
- Seamless inner leg
- Race fit

Item	Size	Colour
860000189	XS	BLACK/BLUE
860000190	S	BLACK/BLUE
860000191	M	BLACK/BLUE
860000192	L	BLACK/BLUE
860000193	XL	BLACK/BLUE
860000194	2XL	BLACK/BLUE
860000195	XS	BLACK/WHITE
860000196	S	BLACK/WHITE
860000197	M	BLACK/WHITE
860000198	L	BLACK/WHITE
860000199	XL	BLACK/WHITE
860000200	2XL	BLACK/WHITE



\$79<sup>99</sup>



## CENTRO SS JERSEY

- TransTextura™ solid and mesh fabrics
- Raglan sleeve cut
- Full length zipper
- UPF 30+ sun protection
- Club fit

Item	Size	Colour
850000662	XS	GRAY/BLACK/RED
850000663	S	GRAY/BLACK/RED
850000664	M	GRAY/BLACK/RED
850000665	L	GRAY/BLACK/RED
850000666	XL	GRAY/BLACK/RED
850000667	2XL	GRAY/BLACK/RED
850000668	XS	GRAY/BLACK/BLUE
850000669	S	GRAY/BLACK/BLUE
850000670	M	GRAY/BLACK/BLUE
850000671	L	GRAY/BLACK/BLUE
850000672	XL	GRAY/BLACK/BLUE
850000673	2XL	GRAY/BLACK/BLUE



\$59<sup>99</sup>



## CENTRO LS JERSEY NEW

- ThermTextura™ fabric delivers excellent warmth at minimal weight
- Warm and quick drying
- Full length locking zipper
- 3 rear pockets
- Reflective accents

Item	Size	Colour
850001317	XS	RED/BLACK/GRAY
850001318	S	RED/BLACK/GRAY
850001319	M	RED/BLACK/GRAY
850001320	L	RED/BLACK/GRAY
850001321	XL	RED/BLACK/GRAY
850001322	2XL	RED/BLACK/GRAY
850001323	XS	BLUE/BLACK/GRAY
850001324	S	BLUE/BLACK/GRAY
850001325	M	BLUE/BLACK/GRAY
850001326	L	BLUE/BLACK/GRAY
850001327	XL	BLUE/BLACK/GRAY
850001328	2XL	BLUE/BLACK/GRAY

\$69<sup>99</sup>



## SPORT SHORT

- High compression Lycra Sport® fabric
- SportComfor™ Chamois
- Compression leg openings
- Seamless inner leg
- UPF 50

Item	Size	Colour: BLACK
860000252	XS	
860000253	S	
860000254	M	
860000255	L	
860000256	XL	
860000257	2XL	



\$89<sup>99</sup>

## SPORT BIB SHORT

- High compression Lycra Sport® fabric
- SportComfor™ Chamois
- Compression leg openings
- Seamless inner leg
- TransTextura™ bib straps
- UPF 50
- Race fit

Item	Size	Colour: BLACK
860000258	XS	
860000259	S	
860000260	M	
860000261	L	
860000262	XL	
860000263	2XL	



\$99<sup>99</sup>

## SPORT BIB KNICKER NEW

- High compression spandex fabric for comfort and muscle support
- TransTextura™ bib straps
- SportComfor™ Chamois provides excellent breathability and support
- High compression leg band

Item	Size
860000501	XS
860000502	S
860000503	M
860000504	L
860000505	XL
860000506	2XL

Colour: BLACK



\$114<sup>99</sup>

## SPORT THERMAL BIB TIGHT NEW

- Warm and quick drying ThermTextura™ fabric delivers excellent warmth at minimal weight
- SportComfor™ Chamois provides excellent breathability and support
- 6" ankle zipper
- 3D contour panels

Item	Size
860000507	XS
860000508	S
860000509	M
860000510	L
860000511	XL
860000512	2XL

Colour: BLACK



\$134<sup>99</sup>

## CORE SHORT

- CoreComfor™ Chamois
- Silicone gel leg gripper
- Seamless inner leg
- UPF 50
- Race fit

Item	Size	Colour: BLACK
860000228	XS	
860000229	S	
860000230	M	
860000231	L	
860000232	XL	
860000233	2XL	



\$59<sup>99</sup>

## CORE KNICKER

- CoreComfor™ Chamois
- Silicone gel leg gripper
- Extends to mid calf
- UPF 50
- Race fit

Item	Size	Colour: BLACK
860000240	XS	
860000241	S	
860000242	M	
860000243	L	
860000244	XL	
860000245	2XL	



\$69<sup>99</sup>

# OFF ROAD APPAREL



## RACE DAY DH SS JERSEY

- Durable TransTextura™ fabric wicks moisture and dries quickly
- High stretch neck and cuffs for better fit and comfort
- UPF 30 sun protection
- Relaxed fit

Item	Size	
850000954	XS	
850000955	S	
850000956	M	
850000957	L	
850000958	XL	
850000959	2XL	



**\$64<sup>99</sup>** Colour: BLUE/BLACK

## RACE DAY DH LS JERSEY

- Durable TransTextura™ fabric wicks moisture and dries quickly
- High stretch neck and cuffs for better fit and comfort
- UPF 30 sun protection
- Relaxed fit

Item	Size	
850000960	XS	
850000961	S	
850000962	M	
850000963	L	
850000964	XL	
850000965	2XL	



**\$69<sup>99</sup>** Colour: BLUE/BLACK

## REALM SS JERSEY

- TransTextura waffle and mesh fabric for all day comfort
- Sublimated pattern matches shorts
- UPF 30+ sun protection

Item	Size	Colour
850001281	XS	GRAY
850001282	S	GRAY
850001283	M	GRAY
850001284	L	GRAY
850001285	XL	GRAY
850001286	2XL	GRAY
850001287	XS	BLUE
850001288	S	BLUE
850001289	M	BLUE
850001290	L	BLUE
850001291	XL	BLUE
850001292	2XL	BLUE



**\$69<sup>99</sup>**

## REALM LS JERSEY

- TransTextura waffle and mesh fabric for all day comfort
- Sublimated pattern matches shorts
- UPF 30+ sun protection

Item	Size	Colour
850001299	XS	GRAY
850001300	S	GRAY
850001301	M	GRAY
850001302	L	GRAY
850001303	XL	GRAY
850001304	2XL	GRAY
850001305	XS	BLUE
850001306	S	BLUE
850001307	M	BLUE
850001308	L	BLUE
850001309	XL	BLUE
850001310	2XL	BLUE



**\$79<sup>99</sup>**

## CORE TRAIL JERSEY

- TransTextura™ fabric provides permanent moisture transfer and sun protection to keep you comfortable
- Hidden zippered stash pocket
- UPF 30 sun protection
- Relaxed fit

Item	Size	Colour
850001335	XS	BLACK
850001336	S	BLACK
850001337	M	BLACK
850001338	L	BLACK
850001339	XL	BLACK
850001340	2XL	BLACK
850001341	XS	BLUE
850001342	S	BLUE
850001343	M	BLUE
850001344	L	BLUE
850001345	XL	BLUE
850001346	2XL	BLUE



**\$54<sup>99</sup>**

## PERFORMANCE TRAIL SHORT

- 2-way and 4-way stretch fabrics for comfort and performance
- Zippered mesh and eyelet vents for temperature control
- Zippered storage pocket on lower back
- Short liner not included

Item	Size	Colour
860000483	XS	GRAY
860000484	S	GRAY
860000485	M	GRAY
860000486	L	GRAY
860000487	XL	GRAY
860000488	2XL	GRAY
860000489	XS	BLUE
860000490	S	BLUE
860000491	M	BLUE
860000492	L	BLUE
860000493	XL	BLUE
860000494	2XL	BLUE



**\$114<sup>99</sup>**

## SPORT TRAIL SHORT

- TransTextura™ durable 2 way stretch fabric shell and mesh liner
- CoreComfor™ Trail chamois with TransTextura Plus™ fabric is highly breathable and lightweight
- External waist adjustment
- 2 open hand pockets and 1 zippered storage pocket

Item	Size	Colour
860000435	XS	GRAY
860000436	S	GRAY
860000437	M	GRAY
860000438	L	GRAY
860000439	XL	GRAY
860000440	2XL	GRAY
860000441	XS	BLACK
860000442	S	BLACK
860000443	M	BLACK
860000444	L	BLACK
860000445	XL	BLACK
860000446	2XL	BLACK



**\$109<sup>99</sup>** 

## REALM TRAIL SHORT

- 2-way stretch fabric for durability and performance
- Zippered mesh and eyelet vents
- Zippered rear stash pocket
- Short liner not included

Item	Size	Colour
860000447	XS	GRAY
860000448	S	GRAY
860000449	M	GRAY
860000450	L	GRAY
860000451	XL	GRAY
860000452	2XL	GRAY
860000453	XS	BLUE
860000454	S	BLUE
860000455	M	BLUE
860000456	L	BLUE
860000457	XL	BLUE
860000458	2XL	BLUE



**\$99<sup>99</sup>**  

## SPORT ENDURO 3/4 SHORT

- 2 way stretch fabric for durability and performance
- Zippered mesh vents on thigh
- Articulated knee for better performance with protective pads
- Short liner not included

Item	Size	Colour
860000465	XS	GRAY
860000466	S	GRAY
860000467	M	GRAY
860000468	L	GRAY
860000469	XL	GRAY
860000470	2XL	GRAY
860000471	XS	BLUE
860000472	S	BLUE
860000473	M	BLUE
860000474	L	BLUE
860000475	XL	BLUE
860000476	2XL	BLUE



**\$109<sup>99</sup>** 

# OUTERWEAR



## REV PRO THERMAL JACKET NEW

- Designed and created in partnership with Etxeondo
- Strategically placed stretch soft-shell panels provide protection where you need while keeping weight down
- Tone on tone print pattern and colored accents tie the entire kit together

Item	Size	Colour
850001377	S	BLACK/GRAY
850001378	M	BLACK/GRAY
850001379	L	BLACK/GRAY
850001380	XL	BLACK/GRAY
850001381	2XL	BLACK/GRAY
850001382	3XL	BLACK/GRAY
850001383	S	BLACK/BLUE
850001384	M	BLACK/BLUE
850001385	L	BLACK/BLUE
850001386	XL	BLACK/BLUE
850001387	2XL	BLACK/BLUE
850001388	3XL	BLACK/BLUE



\$299<sup>99</sup>



## REV PRO RAIN JACKET NEW

- Designed and created in partnership with Etxeondo
- ProTextura™ high stretch waterproof, breathable fabric
- Packable into rear jersey pocket

Item	Size	Colour
850001389	S	BLACK/GRAY
850001390	M	BLACK/GRAY
850001391	L	BLACK/GRAY
850001392	XL	BLACK/GRAY
850001393	2XL	BLACK/GRAY
850001394	3XL	BLACK/GRAY
850001395	S	BLACK/BLUE
850001396	M	BLACK/BLUE
850001397	L	BLACK/BLUE
850001398	XL	BLACK/BLUE
850001399	2XL	BLACK/BLUE
850001400	3XL	BLACK/BLUE



\$279<sup>99</sup>



## SUPERLIGHT WIND JACKET

- ProTextura Lite™ fabric
- Race fit
- Vented underarms
- Reflective accents
- Full length locking zipper
- Jacket packs away into rear pocket

Item	Size	Colour
850000686	XS	WHITE/BLACK
850000687	S	WHITE/BLACK
850000688	M	WHITE/BLACK
850000689	L	WHITE/BLACK
850000690	XL	WHITE/BLACK
850000691	2XL	WHITE/BLACK
850000680	XS	YELLOW/BLACK
850000681	S	YELLOW/BLACK
850000682	M	YELLOW/BLACK
850000683	L	YELLOW/BLACK
850000684	XL	YELLOW/BLACK
850000685	2XL	YELLOW/BLACK



\$89<sup>99</sup>



## CORE WIND JACKET

- ProTextura™ fabric
- Club fit
- Vented back panel
- Rear storage pocket
- Full length locking zipper
- Reflective accents

Item	Size	Colour
850000412	XS	BLACK/GRAY
850000413	S	BLACK/GRAY
850000414	M	BLACK/GRAY
850000415	L	BLACK/GRAY
850000416	XL	BLACK/GRAY
850000417	2XL	BLACK/GRAY
850000406	XS	YELLOW/GRAY
850000407	S	YELLOW/GRAY
850000408	M	YELLOW/GRAY
850000409	L	YELLOW/GRAY
850000410	XL	YELLOW/GRAY
850000411	2XL	YELLOW/GRAY



\$74<sup>99</sup>



# TEAM APPAREL



## GIANT TEAM TRACK JACKET NEW

- ThermTextura™ fabric provides lightweight insulation
- Giant Corporate branding
- UPF 30 sun protection"

Item	Size
880000128	S
880000129	M
880000130	L
880000131	XL
880000132	2XL

Colour: BLACK

**\$74<sup>99</sup>**



## GIANT TEAM HOODIE

- ThermTextura™ fabric provides lightweight insulation
- Giant Corporate branding
- UPF 30 sun protection

Item	Size
8800000122	S
8800000123	M
8800000124	L
8800000125	XL

Colour: GRAY

**\$114<sup>99</sup>**



## GIANT TEAM COOL SHIRT NEW

- TransTextura fabric™ for all day comfort
- Giant Corporate branding
- UPF 30 sun protection

Item	Size
880000116	S
880000117	M
880000118	L
880000119	XL
880000120	2XL

Colour: BLACK

**\$64<sup>99</sup>**



## GIANT TEAM POLO SHIRT NEW

- TransTextura fabric™ for all day comfort
- Giant Corporate branding
- UPF 30 sun protection

Item	Size
880000134	S
880000135	M
880000136	L
880000137	XL
880000138	2XL

Colour: BLACK

**\$54<sup>99</sup>**



# ACCESSORIES



## 3D BASELAYER



- TransTextura Plus™ fabric quickly wicks moisture and eliminates odor causing bacteria
- Raglan sleeve cycling specific construction
- Drop tail design for coverage

Item	Type	Colour	Size	Price
840000051	SLEEVELESS	WHITE	XS	\$39.99
840000052	SLEEVELESS	WHITE	S	\$39.99
840000053	SLEEVELESS	WHITE	M	\$39.99
840000054	SLEEVELESS	WHITE	L	\$39.99
840000055	SLEEVELESS	WHITE	XL	\$39.99
840000057	SLEEVELESS	BLACK	XS	\$39.99
840000058	SLEEVELESS	BLACK	S	\$39.99
840000059	SLEEVELESS	BLACK	M	\$39.99
840000060	SLEEVELESS	BLACK	L	\$39.99
840000061	SLEEVELESS	BLACK	XL	\$39.99

Item	Type	Colour	Size	Price
840000063	SHORT SLEEVE	WHITE	XS	\$44.99
840000064	SHORT SLEEVE	WHITE	S	\$44.99
840000065	SHORT SLEEVE	WHITE	M	\$44.99
840000066	SHORT SLEEVE	WHITE	L	\$44.99
840000067	SHORT SLEEVE	WHITE	XL	\$44.99
840000069	SHORT SLEEVE	BLACK	XS	\$44.99
840000070	SHORT SLEEVE	BLACK	S	\$44.99
840000071	SHORT SLEEVE	BLACK	M	\$44.99
840000072	SHORT SLEEVE	BLACK	L	\$44.99
840000073	SHORT SLEEVE	BLACK	XL	\$44.99

Item	Type	Colour	Size	Price
840000075	LONG SLEEVE	WHITE	XS	\$49.99
840000076	LONG SLEEVE	WHITE	S	\$49.99
840000077	LONG SLEEVE	WHITE	M	\$49.99
840000078	LONG SLEEVE	WHITE	L	\$49.99
840000079	LONG SLEEVE	WHITE	XL	\$49.99
840000081	LONG SLEEVE	BLACK	XS	\$49.99
840000082	LONG SLEEVE	BLACK	S	\$49.99
840000083	LONG SLEEVE	BLACK	M	\$49.99
840000084	LONG SLEEVE	BLACK	L	\$49.99
840000085	LONG SLEEVE	BLACK	XL	\$49.99



## THERMO ARM WARMER

- Internal fleece keeps rider warm
- Ergonomically constructed with flat-lock stitching to provide great all-around comfort and performance
- Lamination provides wind protection on critically exposed areas
- Anti-slip elastic bandings
- Safety reflective accents

Item	Size	Colour:
820000008	S	BLACK
820000009	M	
820000010	L	
820000011	XL	
820000012	XXL	



\$39<sup>99</sup>

## THERMO LEG WARMER

- Internal fleece keeps rider warm
- Ergonomically constructed with flat-lock stitching to provide great all-around comfort and performance
- Lamination provides wind protection on critically exposed areas
- Anti-slip elastic bandings
- Safety reflective accents

Item	Size	Colour:
820000013	S	BLACK
820000014	M	
820000015	L	
820000016	XL	
820000017	XXL	



\$59<sup>99</sup>

## 3D ARM WARMER



- Warm and quick drying ThermTextura™ fabric delivers excellent warmth at minimal weight
- 3D ergonomic cut enhances fit and comfort
- Reflective accents enhance visibility in low light condition

Item	Size	Colour:
820000260	S	BLACK
820000261	M	
820000262	L	



\$34<sup>99</sup>

## UV ARM COOLER



- UV protection that never rubs or washes off
- TransTextura™ moisture management with added cooling keeps you comfortable on the hottest days

Item	Size	Colour:
820000272	S	WHITE
820000273	M	
820000274	L	



\$24<sup>99</sup>

## 3D KNEE WARMER



- Warm and quick drying ThermTextura™ fabric delivers excellent warmth at minimal weight
- 3D ergonomic cut enhances fit and comfort
- Reflective accents enhance visibility in low light condition

Item	Size	Colour:
820000263	S	BLACK
820000264	M	
820000265	L	



\$39<sup>99</sup>

## UV LEG COOLER



- UV protection that never rubs or washes off
- TransTextura™ moisture management with added cooling keeps you comfortable on the hottest days
- Silicon gripper prevents slipping

Item	Size	Colour:
820000278	S	WHITE
820000279	M	
820000280	L	



\$34<sup>99</sup>

## TRANSTEXTURA CYCLING CAP

- Designed to fit under cycling helmet
- Flat seams
- TransTextura Plus™ moisture transfer and anti-odor technology

Item	Size	Colour
820000122	OSFM	BLACK
820000123	OSFM	RED
820000124	OSFM	BLUE



\$19.99



## THERMTEXTURA CYCLING CAP

- ThermTextura™ thermo fleece on inner side
- Foldable ear flap

Item	Size	Colour:
820000130	OSFM	BLACK



\$19.99



## TRANSTEXTURA SKULL CAP

- Under helmet skull cap for summer
- Super vented mesh fabrics keep head cool
- TransTextura™ moisture transfer technology

Item	Size	Colour
820000120	OSFM	BLACK
820000121	OSFM	WHITE



\$14.99



## THERMTEXTURA SKULL CAP

- ThermTextura™ thermo fleece inner
- Soft and stretchy material provides comfort
- Covers ears and provides extra warmth

Item	Size	Colour:
820000129	OSFM	BLACK



\$19.99



## HEADBAND

- Thermo headband covers forehead and ears
- Stretchy Lycra material provides perfect fit
- ThermTextura™ thermo fleece on inner side

Item	Size	Colour:
820000125	OSFM	BLACK



\$14.99



## TEAM CAP

- Classic 6-panel structure with vents
- Adjustable fit

Item	Size	Colour:
820000106	OSFM	BLUE



\$19.99



## RACE DAY SOCK



- Ultra high gauge 200 needle count construction for thin and smooth feel
- TransTextura Plus™ fabric quickly wicks moisture and eliminates odor
- Left and Right specific fit
- Arch compression band

Item	Size	Colour
820000389	S	WHITE
820000390	M	WHITE
820000391	L	WHITE
820000392	S	BLACK
820000393	M	BLACK
820000394	L	BLACK

\$16.99



## GIANT SHIMANO TEAM SOCK



- Ultra high gauge 200 needle count construction for thin and smooth feel
- TransTextura Plus™ fabric quickly wicks moisture and eliminates odor causing bacteria
- Left and Right specific fit
- Arch compression band
- Official sock of the Giant/Shimano Pro Tour team

Item	Size	Colour:
820000325	S	WHITE
820000326	M	
820000327	L	

\$19.99



## REV LITE SOCK

- Light weight, designed to be worn with road shoes
- Left- and right-specific socks for ideal fit
- Arch compression band and ergo cushioning
- TransTextura Plus™ moisture transfer and anti-odor

Item	Size	Colour
820000166	S	BLACK
820000167	M	BLACK
820000168	L	BLACK
820000169	S	WHITE
820000170	M	WHITE
820000171	L	WHITE



\$14<sup>99</sup>



## ALLY TALL SOCK NEW

- High gauge 144 needle count for thin and smooth feel
- TransTextura™ technology
- Ventilation mesh top
- Flat seam and seamless heel closure

Item	Size	Colour
820000377	S	BLACK
820000378	M	BLACK
820000379	L	BLACK
820000380	S	WHITE
820000381	M	WHITE
820000382	L	WHITE



\$10<sup>49</sup>



## ALLY SOCK

- Full fashion knitted mesh panel offers ventilation
- Flat-seam toe box, seamless heel closure
- TransTextura™ fabric wicks moisture and dries quickly

Item	Size	Colour	Quantity
820000148	S	BLACK	1 PAIR
820000149	M	BLACK	1 PAIR
820000150	L	BLACK	1 PAIR
820000151	S	WHITE	1 PAIR
820000152	M	WHITE	1 PAIR
820000153	L	WHITE	1 PAIR
820000160	S	BLACK	3-PACK
820000161	M	BLACK	3-PACK
820000162	L	BLACK	3-PACK
820000163	S	WHITE	3-PACK
820000164	M	WHITE	3-PACK
820000165	L	WHITE	3-PACK



\$7<sup>99</sup>/pair \$19<sup>99</sup>/3-pack

## REALM SOCK

- Specifically designed to be worn with mountain bike shoes
- Left- and right-specific socks for ideal fit
- 3D mesh panels and ribbing offer ventilation and ankle protection
- Arch compression band and ergo cushioning
- TransTextura Plus™ moisture transfer and anti-odor

Item	Size	Colour
820000172	S	BLACK
820000173	M	BLACK
820000174	L	BLACK
820000175	S	GRAY
820000176	M	GRAY
820000177	L	GRAY



\$14<sup>99</sup>

## MERINO REALM SOCK

- Genuine Merino wool, insulates, ventilates, wicks moisture
- Arch compression band and ergo cushioning
- Nylon-reinforced heel and toe

Item	Size	Colour
820000178	S	BLACK
820000179	M	BLACK
820000180	L	BLACK
820000181	S	GRAY
820000182	M	GRAY
820000183	L	GRAY



\$16<sup>99</sup>

## ACTIVE COMPRESSION SOCK NEW

- TransTextura™ fabric
- Left and Right specific fit
- Compression varies from 15mm at arch to 12mm at top

Item	Size	Colour
820000340	S	BLACK
820000341	M	BLACK
820000342	L	BLACK
820000343	XL	BLACK



\$19<sup>99</sup>

# GLOVES



## TEAM REGULATOR GLOVE



- Wind and waterproof winter glove with thermo fleece
- Long cuff blocks cold air
- Authentic professional team gear



Item	Size	Colour
830000061	S	BLUE/WHITE
830000062	M	BLUE/WHITE
830000063	L	BLUE/WHITE
830000064	XL	BLUE/WHITE
830000065	2XL	BLUE/WHITE

\$64<sup>99</sup>

## TEAM GLOVE



- Mesh palm area provides extremely good ventilation
- Elastic cuff is light-weight and comfortable
- Authentic professional team gear



Item	Size	Colour
830000055	S	BLUE/WHITE
830000056	M	BLUE/WHITE
830000057	L	BLUE/WHITE
830000058	XL	BLUE/WHITE
830000059	2XL	BLUE/WHITE

\$44<sup>99</sup>

## REV LONG FINGER GLOVE

\$39<sup>99</sup>

- Breathable 4-way stretch mesh panels
- Elastic wrist closure
- Pre-curved ergo construction
- TipTech™ smartphone-friendly fingertips



Item	Size	Colour
830000368	XS	BLACK
830000369	S	BLACK
830000370	M	BLACK
830000371	L	BLACK
830000372	XL	BLACK
830000243	XS	BLACK/BLUE
830000244	S	BLACK/BLUE
830000245	M	BLACK/BLUE
830000246	L	BLACK/BLUE
830000247	XL	BLACK/BLUE
830000248	XS	GRAY/GREEN
830000249	S	GRAY/GREEN
830000250	M	GRAY/GREEN
830000251	L	GRAY/GREEN
830000252	XL	GRAY/GREEN
830000253	XS	WHITE/RED
830000254	S	WHITE/RED
830000255	M	WHITE/RED
830000256	L	WHITE/RED
830000257	XL	WHITE/RED



## REV SHORT FINGER GLOVE

\$34<sup>99</sup>

- Breathable 4-way stretch mesh panels
- Elastic wrist closure
- Pre-curved ergo construction



Item	Size	Colour
830000373	XS	BLACK
830000374	S	BLACK
830000375	M	BLACK
830000376	L	BLACK
830000377	XL	BLACK
830000258	XS	BLACK/BLUE
830000259	S	BLACK/BLUE
830000260	M	BLACK/BLUE
830000261	L	BLACK/BLUE
830000262	XL	BLACK/BLUE
830000263	XS	GRAY/GREEN
830000264	S	GRAY/GREEN
830000265	M	GRAY/GREEN
830000266	L	GRAY/GREEN
830000267	XL	GRAY/GREEN
830000268	XS	WHITE/RED
830000269	S	WHITE/RED
830000270	M	WHITE/RED
830000271	L	WHITE/RED
830000272	XL	WHITE/RED



## STREAK GEL LONG FINGER GLOVE

\$34<sup>99</sup>

- TipTech™ smartphone-friendly fingertips
- Soft nose wipe zone on thumb
- Plush Gel™ multi-thickness memory-foam padding
- Pre-curved ergo construction



Item	Size	Colour
830000358	XS	BLACK
830000359	S	BLACK
830000360	M	BLACK
830000361	L	BLACK
830000362	XL	BLACK
830000140	XS	BLUE
830000141	S	BLUE
830000142	M	BLUE
830000143	L	BLUE
830000144	XL	BLUE
830000150	XS	GRAY
830000151	S	GRAY
830000152	M	GRAY
830000153	L	GRAY
830000154	XL	GRAY



## STREAK GEL SHORT FINGER GLOVE

\$29<sup>99</sup>

- Soft nose wipe zone on thumb
- Plush Gel™ multi-thickness memory-foam padding
- Pre-curved ergo construction



Item	Size	Colour
830000363	XS	BLACK
830000364	S	BLACK
830000365	M	BLACK
830000366	L	BLACK
830000367	XL	BLACK
830000155	XS	BLUE
830000156	S	BLUE
830000157	M	BLUE
830000158	L	BLUE
830000159	XL	BLUE
830000165	XS	GRAY
830000166	S	GRAY
830000167	M	GRAY
830000168	L	GRAY
830000169	XL	GRAY



## HORIZON LONG FINGER GLOVE

- Reinforced, double-layered, padded Clarino™ palm
- Anti-Slip silicon print
- Elastic neoprene cuff with micro-Velcro® closure
- Soft nose wipe zone on thumb

Item	Size	Colour
830000080	XS	GRAY
830000081	S	GRAY
830000082	M	GRAY
830000083	L	GRAY
830000084	XL	GRAY
830000348	XS	BLACK
830000349	S	BLACK
830000350	M	BLACK
830000351	L	BLACK
830000352	XL	BLACK
830000090	XS	BLUE
830000091	S	BLUE
830000092	M	BLUE
830000093	L	BLUE
830000094	XL	BLUE
830000095	XS	RED
830000096	S	RED
830000097	M	RED
830000098	L	RED
830000099	XL	RED



**\$34<sup>99</sup>**

## HORIZON SHORT FINGER GLOVE

- Reinforced, double-layered, padded Clarino™ palm
- Anti-Slip silicon print
- Elastic neoprene cuff with micro-Velcro® closure
- Soft nose wipe zone on thumb

Item	Size	Colour
830000105	XS	GRAY
830000106	S	GRAY
830000107	M	GRAY
830000108	L	GRAY
830000109	XL	GRAY
830000353	XS	BLACK
830000354	S	BLACK
830000355	M	BLACK
830000356	L	BLACK
830000357	XL	BLACK
830000115	XS	BLUE
830000116	S	BLUE
830000117	M	BLUE
830000118	L	BLUE
830000119	XL	BLUE
830000120	XS	RED
830000121	S	RED
830000122	M	RED
830000123	L	RED
830000124	XL	RED



**\$29<sup>99</sup>**

## ALL MOUNTAIN GLOVE

- Double layered in high wear areas, light palm heel padding
- Pre-curved ergo construction
- TipTech™ smartphone-friendly fingertips

Item	Size	Colour
830000461	XS	BLACK
830000462	S	BLACK
830000463	M	BLACK
830000464	L	BLACK
830000465	XL	BLACK
830000288	XS	BLACK/BLUE
830000289	S	BLACK/BLUE
830000290	M	BLACK/BLUE
830000291	L	BLACK/BLUE
830000292	XL	BLACK/BLUE
830000293	XS	GRAY/WHITE
830000294	S	GRAY/WHITE
830000295	M	GRAY/WHITE
830000296	L	GRAY/WHITE
830000297	XL	GRAY/WHITE
830000298	XS	GRAY/GREEN
830000299	S	GRAY/GREEN
830000300	M	GRAY/GREEN
830000301	L	GRAY/GREEN
830000302	XL	GRAY/GREEN



**\$49<sup>99</sup>**

## REALM GLOVE

- Reinforced protection on palm and knuckles
- Pre-curved ergo construction
- TipTech™ smartphone-friendly fingertips

Item	Size	Colour
830000446	XS	BLACK
830000447	S	BLACK
830000448	M	BLACK
830000449	L	BLACK
830000450	XL	BLACK
830000273	XS	BLACK/BLUE
830000274	S	BLACK/BLUE
830000275	M	BLACK/BLUE
830000276	L	BLACK/BLUE
830000277	XL	BLACK/BLUE
830000278	XS	GRAY/WHITE
830000279	S	GRAY/WHITE
830000280	M	GRAY/WHITE
830000281	L	GRAY/WHITE
830000282	XL	GRAY/WHITE
830000283	XS	GRAY/GREEN
830000284	S	GRAY/GREEN
830000285	M	GRAY/GREEN
830000286	L	GRAY/GREEN
830000287	XL	GRAY/GREEN



**\$44<sup>99</sup>**

## CHILL X

- ProTextura™ and Therm-Textura™ provide warmth and weather protection
- Thinsulate™ insulation
- Single layer Amara™ leather palm
- Bolton thumb construction for impeccable fit
- Long velcro wrist opening with magnet connectors

Item	Size
830000476	S
830000477	M
830000478	L
830000479	XL

**\$44<sup>99</sup>**



## CHILL

- Early winter glove with stretchy fleece Lycra back
- Soft nose wipe zone on thumb
- Silicon appliqué on palm & fingers for all-weather grip
- TipTech™ smartphone-friendly fingertips

Item	Size
830000175	XS
830000176	S
830000177	M
830000178	L
830000179	XL

**\$34<sup>99</sup>** Colour: BLACK



## CHILL LITE

- Wind and water resistant, thermo fleece on inside
- Silicon appliqué on palm & fingers for all-weather grip
- Pre-curved ergo construction
- TipTech™ smartphone-friendly fingertips

Item	Size
830000170	XS
830000171	S
830000172	M
830000173	L
830000174	XL

**\$29<sup>99</sup>** Colour: BLACK



# ON ROAD HELMETS



## REV

- LiteForm™ webbing for comfort and performance
- Internal Structural Shell (ISS) for strength at reduced weight
- Giant CINCH+™ fit system for simple and easy head-hugging comfort
- 21 vent configuration for optimal airflow and top-of-the-head ventilation
- Proprietary TransTextura Plus™ anti-microbial fast wicking pad technology

 \$159<sup>99</sup>

Item	Size	Colour
800000132	S	RACE BLUE
800000133	M	RACE BLUE
800000134	L	RACE BLUE
800000135	S	LASER BLUE
800000136	M	LASER BLUE
800000137	L	LASER BLUE
800000138	S	LASER FLUORESCENT
800000139	M	LASER FLUORESCENT
800000140	L	LASER FLUORESCENT
800000141	S	LASER RED
800000142	M	LASER RED
800000143	L	LASER RED
800000144	S	LASER WHITE
800000145	M	LASER WHITE
800000146	L	LASER WHITE



RACE BLUE



LASER BLUE



LASER FLUORESCENT



LASER RED



LASER WHITE



## STREAK

- Giant CINCH+™ fit system for simple and easy head-hugging comfort
- 19 vent configuration for optimal airflow and top-of-the-head ventilation
- Proprietary TransTextura Plus™ anti-microbial fast wicking pad technology
- Removable Streak visor
- Locking Giant cam-buckles

Item	Size	Colour
800000111	S	LUNAR-FLUORESCENT
800000112	M	LUNAR-FLUORESCENT
800000113	L	LUNAR-FLUORESCENT
800000114	S	TECH BLUE
800000115	M	TECH BLUE
800000116	L	TECH BLUE
800000117	S	TECH BLACK
800000118	M	TECH BLACK
800000119	L	TECH BLACK
800000123	S	TECH WHITE
800000124	M	TECH WHITE
800000125	L	TECH WHITE



\$99<sup>99</sup>



## ALLY

- Giant Cinch 5™ Full-Ring fit system for simple and easy adjustability
- 27 vents for optimal airflow and cooling
- Locking Giant cam-buckles
- In-mold EPS construction with nylon reinforcement
- Removable visor, making it adaptable to all daily riding conditions.

Item	Size	Colour
800000104	OSFM	ILLUM-RED
800000105	OSFM	ILLUM-BLUE
800000106	OSFM	BLUE/WHITE
800000108	OSFM	CHARCOAL
800000193	XL	ILLUM-RED
800000194	XL	ILLUM-BLUE
800000195	XL	BLUE/WHITE
800000197	XL	CHARCOAL



\$79<sup>99</sup>



## HORIZON

- Giant Cinch 5™ Full-Ring fit system with LED for simple and easy adjustability
- 18 vent configuration for optimal airflow and cooling
- In-mold EPS with reinforced internal nylon strengthening
- Visor included
- Locking Giant cam-buckles

\$44<sup>99</sup>

Item	Size	Colour
800000097	OSFM	FLUORESCENT SPEED
800000098	OSFM	WHITE SPEED
800000101	OSFM	BLACK
800000181	XL	FLUORESCENT SPEED
800000182	XL	WHITE SPEED
800000185	XL	BLACK



# OFF ROAD HELMETS



## ARGUS

- Giant Cinch 5™ Full-Ring fit system for simple and easy adjustability
- 18 vents for optimal airflow and cooling
- In-mold EPS with internal nylon strengthening and under-wrap shell protection, for increased durability and longevity
- 3-point, 12-degree adjustable visor
- Locking Giant cam-buckles



Item	Size	Colour
800000153	OSFM	GREEN
800000154	OSFM	BLACK
800000155	OSFM	SPEED CHARCOAL
800000234	XL	GREEN
800000235	XL	BLACK
800000236	XL	SPEED CHARCOAL

\$59<sup>99</sup>

## FACTOR

- Hard density ABS outer shell construction
- Removable/washable internal liners for ultimate hygiene
- 8 optimized vents for protection and cooling + large center mouth-port
- Adjustable visor
- Foam lined inner chin-bar area



Item	Size	Colour
800000246	S/M	TEAM BLUE
800000247	L/XL	TEAM BLUE

\$149<sup>99</sup>

## VAULT

- Hard density ABS outer shell construction, with EPS internal
- 11 air vents for cooling
- Extra set of pads included
- Locking Giant cam-buckles



Item	Size	Colour
800000067	S/M	BLUE/GREEN
800000068	L/XL	BLUE/GREEN
800000069	S/M	WHITE/BLUE
800000070	L/XL	WHITE/BLUE
800000071	S/M	BLACK
800000072	L/XL	BLACK

\$39<sup>99</sup>

# YOUTH HELMETS

## VAULT JR.

- Hard density ABS outer shell construction, with EPS internal
- 11 air vents for cooling
- Extra set of pads included
- Locking Giant cam-buckles



Item	Size	Colour
800000064	OSFM	GRAY
800000065	OSFM	BLUE
800000066	OSFM	WHITE

\$39<sup>99</sup>



## EXEMPT YOUTH

- Giant Cinch 5™ Full-Ring fit system with LED lighting for simple and easy adjustability
- 18 vents for optimal airflow and cooling
- 3-point, 12-degree adjustable visor
- In-mold EPS with internal nylon strengthening and under-wrap shell protection, for increased durability and longevity
- Locking Giant cam-buckles



Item	Size	Colour
800000095	OSFM	CHARCOAL/BLUE
800000096	OSFM	PLAID BLUE

\$59<sup>99</sup>



## INCITE YOUTH

- Giant Cinch 5™ Full-Ring fit system with LED for simple and easy adjustability
- 18 vent configuration for optimal airflow and cooling
- In-mold EPS with reinforced internal nylon strengthening
- Visor included
- Locking Giant cam-buckles



Item	Size	Colour
800000092	OSFM	YELLOW/BLACK
800000093	OSFM	GRAY/CHARCOAL

\$39<sup>99</sup>



## SHINE YOUTH

- Giant Cinch 5™ Full-Ring fit system with LED for simple and easy adjustability
- 18 vent configuration for optimal airflow and cooling
- In-mold EPS with reinforced internal nylon strengthening
- Visor included
- Locking Giant cam-buckles



Item	Size	Colour
800000094	OSFM	WHITE/BLUE

\$39<sup>99</sup>



## CUB

- Pinch resistant strap padding
- EZ Cinch™ Full-Ring fit system
- 6 air vents for great air flow
- Extra set of pads for Best-Fit solution
- Locking Giant cam-buckles

\$34<sup>99</sup>



Item	Size	Colour
800000060	OSFM	YELLOW
800000061	OSFM	PINK



## PUP

- EZ Cinch™ Full-Ring fit system with red "Be-Seen" LED lighting
- 12 vent configuration for optimal airflow and cooling
- Pinch resistant strap padding & extra set of pads
- Fused PC Shell to EPS liner for better graphic application and overall outlook, quality and weight reduction
- Locking Giant cam-buckles

\$34<sup>99</sup>



Item	Size	Colour
800000062	OSFM	BLUE
800000063	OSFM	PINK





# ENGINEERING A BETTER WHEEL

**SUPERLIGHT, STIFF AND FAST. EVERY GIANT WHEELSYSTEM IS PURPOSE-BUILT TO BALANCE LIGHTWEIGHT PERFORMANCE, OPTIMAL STIFFNESS, AND MAXIMUM POWER TRANSFER FOR WHATEVER STYLE OF RIDING YOU PREFER.**

Whether the wheel is built for on-road or off-road use, it's all about helping riders climb, corner, sprint and descend with confidence and speed. The design philosophy behind Giant WheelSystems is called System Engineered Performance. Engineers studied the ways that the components—rims, hubs, spokes and other small parts—affect each other. From there, they developed parts that work together, as part of a system, to deliver best-in-class performance.

Here are some of the technologies behind this year's Giant WheelSystems:

## GIANT WHEELSYSTEMS TECHNOLOGY



### 1 RECTANGULAR LEVERAGE ANGLE

**FEATURES:** Strategic placement of the spokes at a near 90-degree angle between the hub and rim.

**BENEFIT:** Optimizes rotational stiffness for maximum pedaling power and minimal wheel windup. The overall stiff feel of the WheelSystem also improves braking response for increased traction and control.

### 2 OPTIMIZED ANCHOR POINT

**FEATURES:** Driveside bracing angle increased nearly 2mm without affecting required gear spacing.

**BENEFIT:** Boosts lateral stiffness for a stronger, stiffer wheel that tracks more accurately, resulting in better cornering and control.

### 3 PRECISION HUB INTERNALS

**FEATURES:** Proprietary hub shells featuring race-proven Swiss-engineered hub internals.

**BENEFIT:** Dependable performance in demanding conditions. All hub parts are readily available and serviceable by your local retailer.

### 4 ADVANCED MATERIALS

**FEATURES:** Handbuilt rims made with composite, scandium or high-strength proprietary aluminum alloys.

**BENEFIT:** Improved rim strength and stiffness with lower rotational mass. Reliable, lightweight performance to help you ride faster.

### 5 TUBELESS DESIGN

**FEATURES:** Offered in Tubeless Ready or Tubeless Compatible configurations, all rims are designed for tubeless ready tire beads.

**BENEFIT:** Ability to run lower air pressure allows the tire to conform better to the road surface or terrain for improved traction, lower rolling resistance and a reduced risk of pinch flats.

# OFF ROAD WHEELSYSTEMS



## P-XCR 27.5 0

Super light, stiff and fast. At just 1400 grams, this is a high-performance wheelsystem designed for XC racing and fast trail riding.

### FEATURES

- Tubeless compatible composite 27.5-inch rims, 25mm width (ETRTO 584x19)
- Durable precision Swiss hub internals
- Interchangeable hub platforms
- 1400g

Front: **\$839<sup>99</sup>**      Rear: **\$1259<sup>99</sup>**  
 350000035      350000036



## P-XCR 27.5 1C NEW

### FEATURES

- Lightweight composite 27.5-inch rims
- Tubeless Compatible using the supplied rim strips and valves
- 25mm wide rim for better tire performance
- Sapim Race stainless steel spokes
- Locking alloy nipples, black
- Giant alloy hub shell, 6-bolt disc compatible, precision internals
- Sealed cartridge bearings
- Interchangeable hub platforms
- 1580g

Front: **\$479<sup>99</sup>**      Rear: **\$719<sup>99</sup>**  
 350000043      350000044

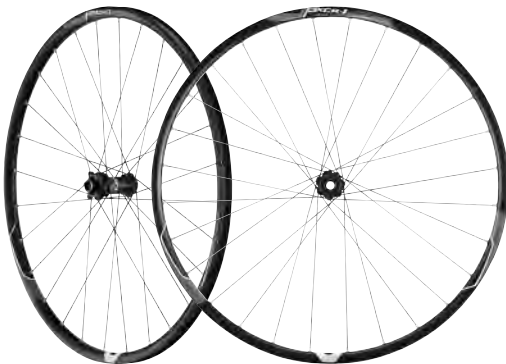

## P-XCR 27.5 1

All the fun of 26-inch wheels with the efficiency of 29. This is a no-holds-barred wheelsystem designed for confidence and pinpoint control.

### FEATURES

- Tubeless compatible alloy 27.5-inch rims, 25mm width (ETRTO 584x19)
- Durable precision Swiss hub internals
- Interchangeable hub platforms
- 1655g

Front: **\$319<sup>99</sup>**      Rear: **\$479<sup>99</sup>**  
 350000039      350000040





## P-TRX 27.5 0

Designed to tackle challenging, technical trails, this 27.5 option offers stiffness, durability and control in all types of terrain.

### FEATURES

- Tubeless compatible composite 27.5-inch rims, 25mm width (ETRTO 584x21)
- Durable precision Swiss hub internals
- Interchangeable hub platforms
- 1440g

Front: **\$839<sup>99</sup>** 350000037    Rear: **\$1259<sup>99</sup>** 350000038



## P-TRX 27.5 1C

### FEATURES

- Lightweight composite 27.5-inch rims
- Tubeless Compatible using the supplied rim strips and valves
- 27mm wide rim for better tire performance
- Sapim Race stainless steel spokes
- Locking alloy nipples, black
- Giant alloy hub shell, 6-bolt disc compatible, precision internals
- Sealed cartridge bearings
- Interchangeable hub platforms
- 1610g

Front: **\$479<sup>99</sup>** 350000045    Rear: **\$719<sup>99</sup>** 350000046

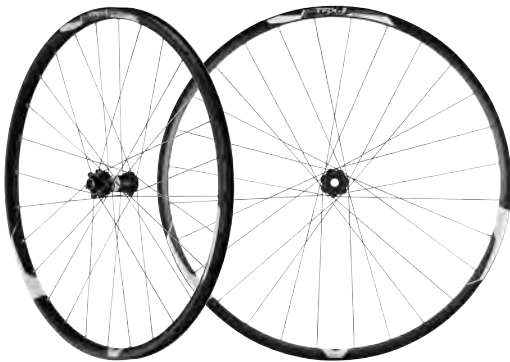

## P-TRX 27.5 1

The all-new P-TRX 27.5 1 delivers absolute confidence and pinpoint control in a wide variety of off-road terrain.

### FEATURES

- Tubeless compatible alloy 27.5-inch rims, 27mm width (ETRTO 584x21)
- Durable precision Swiss hub internals
- Interchangeable hub platforms
- 1675g

Front: **\$319<sup>99</sup>** 350000041    Rear: **\$479<sup>99</sup>** 350000042

# ON ROAD WHEELSYSTEMS



## P-SLRO AERO NEW

### FEATURES

- Ultralight 55mm deep full-composite clincher rims
- 23mm wide rim for better tire and aerodynamic performance
- Proprietary composite braking surface to enhance braking performance
- All hub and rim surface profiles are optimized for maximum aerodynamic performance
- Aerolite bladed stainless steel spokes
- Locking internal alloy nipples increase aerodynamics
- Swiss hub internals
- Single-handed wheel release design
- Tubeless Compatible rim design
- 1610g

Front: **\$919<sup>99</sup>**      Rear: **\$1379<sup>99</sup>**  
 350000067      350000068



## P-SLRO DISC NEW

### FEATURES

- Ultralight 30mm deep full-composite disc brake only rims
- 23mm wide rim for better tire performance
- Sapim CX-Ray stainless steel spokes
- Locking alloy nipples
- Giant 6-bolt disc compatible hubs
- Swiss hub internals
- Interchangeable hub platforms
- Single-handed wheel release design
- Tubeless Compatible rim design
- 1520g

Front: **\$839<sup>99</sup>**      Rear: **\$1259<sup>99</sup>**  
 350000047      350000048



## P-SLR1 AERO NEW

### FEATURES

- Lightweight 55mm deep rims, aluminum-composite construction
- 23mm wide rim for better tire and aerodynamic performance
- CNC-machined alloy braking surface
- All hub and rim surface profiles are optimized for maximum aerodynamic performance
- Aerolite bladed stainless steel spokes
- Locking internal alloy nipples for increased aerodynamics
- Swiss hub internals
- Tubeless Compatible rim design
- 1745g

Front: **\$499<sup>99</sup>**      Rear: **\$699<sup>99</sup>**  
 350000057      350000058



## P-SLR1 NEW

### FEATURES

- Ultra-light 21mm deep Scandium alloy rims, welded
- 21mm wide rim for better tire and aerodynamic performance
- CNC-machined alloy braking surface
- Asymmetric rear rim design increases lateral rigidity and more uniform spoke tension for a stronger, stiffer wheel
- Aerolite bladed stainless steel spokes
- Locking alloy nipples, black
- 1390 grams

Front: **\$399<sup>99</sup>**      Rear: **\$599<sup>99</sup>**  
 350000061      350000062





# TOTALLY CONNECTED

HANDLEBAR, STEM AND SEATPOST. THESE ARE THE CRITICAL CONNECTIONS BETWEEN BODY & BIKE.

These high-quality cockpit components are engineered and purpose-built to take your bike's performance to a higher level. Whether you ride on-road or off-road, each plays a big role in the factors that address your ride. Power transfer, control, compliance—all of these things can be improved with optimized cockpit components.

## CONTACT SLR COMPOSITE ROAD COMPONENTS

The Contact SLR series represents Giant's total commitment to System Engineered Performance. Each component is stiff, lightweight and fine-tuned to reduce vibration and dramatically improve aerodynamic performance so you can ride faster with less effort.

### CONTACT SLR HANDLEBAR

1. Ultra-light, full-composite construction fine-tuned for vibration damping
2. Dual radius drop and ovalized top profile with 3° rearward sweep for maximum comfort

### CONTACT SLR STEM

3. Stiff, lightweight full-composite Box section design to optimize the performance benefits of GIANT OverDrive 2 technology
4. Ten length options: 60-130mm with half sizes from 115-130mm for a perfect fit for performance-oriented riders

### CONTACT SLR SEATPOST

5. One-piece molded full-composite shaft and head
6. Reversible outer clamp design allows for 12mm or 23mm offset options



## CONTACT SL OFF-ROAD COMPONENTS

Giant off-road components feature extra-wide handlebars and stems engineered to maximize torsional stiffness for confidence, control and incredible power delivery. And the Contact SL Switch adjustable seatpost helps you master the trickiest trails. It's instinctively easy to use, lightweight, and durable.

### CONTACT SL TRAIL RISER

1. Lightweight, 2014 aluminum alloy tuned and optimized to reduce vibration
2. Wider 730mm width maximizes torsional stiffness while providing pinpoint control
3. Laser-etched micro-adjust set-up markings for quick, precise setup

### CONTACT SL STEM

4. Lightweight, 3D forged, 2014 aluminum alloy box-style cross-section designed to balance weight, stiffness and performance
5. Oversized 46mm wide 6061 alloy faceplate supports and secures bars for improved stiffness

### CONTACT SL SWITCH SEATPOST

6. Smooth proprietary air & oil cartridge offers more consistent load range adjustment
7. Anti-Twist Technology keeps the saddle firmly positioned
8. New & improved design effortlessly switches from external to internal cable routing



# HANDLEBARS



## CONTACT SLR AERO INTEGRATED BAR/STEM

- Ultra light, one piece full composite construction
- 12width/length options for optimum fit
- OD2 for improved steering stiffness (OD1 compatible)
- Clip on aerobar compatible



Item	Clamp	Width	Length	Drop	Reach	Weight
180000055	31.8mm	38cm	70mm	120mm	80mm	355g
180000056	31.8mm	38cm	80mm	120mm	80mm	360g
180000057	31.8mm	38cm	90mm	120mm	80mm	365g
180000058	31.8mm	40cm	80mm	130mm	80mm	370g
180000059	31.8mm	40cm	90mm	130mm	80mm	375g
180000060	31.8mm	40cm	100mm	130mm	80mm	380g
180000061	31.8mm	42cm	100mm	135mm	90mm	390g
180000062	31.8mm	42cm	110mm	135mm	90mm	395g
180000063	31.8mm	42cm	120mm	135mm	90mm	400g
180000064	31.8mm	44cm	100mm	140mm	95mm	400g
180000065	31.8mm	44cm	110mm	140mm	95mm	405g
180000066	31.8mm	44cm	120mm	140mm	95mm	410g

**\$499<sup>99</sup>**

## CONTACT SLR ROAD NEW

- Ultralight SLR composite construction
- Dual radius drop and ovalized top profile with 3 degree rearward sweep
- Five widths 36-44cm with size specific ergonomic reach and drop
- Compatible with the new Contact Aero Clip-on system
- 180g-205g



Item	Clamp	Width	Drop	Reach
180000141	31.8mm	360mm	120mm	65
180000142	31.8mm	380mm	120mm	70
180000143	31.8mm	400mm	130mm	75
180000144	31.8mm	420mm	135mm	80
180000145	31.8mm	440mm	140mm	85

**\$249<sup>99</sup>**

## CONTACT ROAD NEW

- 2014 aluminum alloy construction
- Dual radius drop for comfort
- Ergonomic deep drop & reach for larger hands
- Micro adjust setup markings
- 265g-300g



Item	Clamp	Width	Drop	Reach
180000152	31.8mm	360mm	120	70
180000153	31.8mm	380mm	120	70
180000154	31.8mm	400mm	120	70
180000155	31.8mm	400mm	125	75
180000156	31.8mm	420mm	125	75
180000157	31.8mm	440mm	125	75

**\$39<sup>99</sup>**

## CONTACT SLR AERO HANDLEBAR

- Ultra light, one piece full composite construction
- Dual radius drop and aero top profile
- Clip on aerobar compatible



Item	Clamp	Width	Drop	Reach	Weight
180000010	31.8mm	38cm	120mm	80mm	215g
180000011	31.8mm	40cm	130mm	80mm	225g
180000012	31.8mm	42cm	135mm	90mm	230g
180000013	31.8mm	44cm	140mm	95mm	245g

**\$259<sup>99</sup>**

## CONTACT SL ROAD NEW

- Lightweight optimized 2014 aluminum alloy construction
- Dual radius drop and ovalized top profile
- Micro adjust set-up markings
- Compatible with the new Contact Aero Clip-on system
- 250g-275g



Item	Clamp	Width	Drop	Reach
180000146	31.8mm	360mm	120	70
180000147	31.8mm	380mm	120	70
180000148	31.8mm	400mm	120	70
180000149	31.8mm	400mm	125	75
180000150	31.8mm	420mm	125	75
180000151	31.8mm	440mm	125	75

**\$79<sup>99</sup>**

## CONNECT XR NEW

- Short and shallow reach and drop for easy access to the controls
- Dual Radius drops flared outward for greater stability in the drops
- Ovalized top profile for greater comfort



Item	Clamp	Width
180000158	31.8mm	380mm
180000159	31.8mm	400mm
180000160	31.8mm	420mm
180000161	31.8mm	440mm

**\$29<sup>99</sup>**

## CONTACT SLR XC FLAT

- Ultralight SLR composite construction creates maximum stiffness with lowest possible weight
- 9 degree sweep
- Micro adjust set-up markings
- Compatible with bar ends when used with included handlebar plugs



Item	Size
180000119	690mm

**\$159<sup>99</sup>**

## CONTACT SLR XC RISER

- Ultralight SLR composite construction creates maximum stiffness with lowest possible weight
- 9 degree sweep
- Micro adjust set-up markings
- Compatible with bar ends when used with included handlebar plugs



Item	Size
180000120	690mm

**\$169<sup>99</sup>**

## CONTACT SL XC FLAT

- Lightweight optimized 2014 aluminum alloy
- Micro adjust laster etched set-up markings
- 5 degree rearward sweep



Item	Size
180000123	620mm

**\$44<sup>99</sup>**

## CONTACT SL TRAIL RISER

- Lightweight 2014 aluminum alloy construction
- 9 degree rearward / 5 degree upward sweep
- 19mm rise



Item	Size
180000125	730mm

**\$64<sup>99</sup>**

## CONTACT SL DH

- Lightweight 2014 aluminum alloy construction
- 800mm width maximizes torsional stiffness to provide pinpoint control
- Race proven 5 degree rearward / 5 degree upward sweep
- 19mm rise



Item	Size
180000126	800mm

**\$79<sup>99</sup>**

## CONTACT XC RISER

- Tough 2014 aluminum alloy
- 9 degree rearward / 5 degree upward sweep
- 19mm rise



Item	Size
180000128	690mm

**\$34<sup>99</sup>**

## CONTACT TRAIL RISER

- Tough 2014 aluminum alloy
- 9 degree rearward / 5 degree upward sweep
- 19mm Rise



Item	Size
180000130	730mm

**\$34<sup>99</sup>**

## CONNECT XC RISER

- Tough 2014 aluminum alloy
- 9 degree rearward / 5 degree upward sweep
- 19mm rise



Item	Size
180000134	690mm

**\$19<sup>99</sup>**

## CONNECT XC FLAT

- Aluminum Alloy Construction
- 9 degree rearward / 0 degree upward sweep
- 0mm Rise



Item	Size
180000140	620mm

**\$19<sup>99</sup>**

## CONNECT TRAIL RISER

- Tough 2014 aluminum alloy
- 9 degree rearward / 5 degree upward sweep
- 19mm Rise



Item	Size
180000138	730mm

**\$19<sup>99</sup>**

## CONTACT SLR AERO INTEGRATED COMPUTER MOUNT

- Designed to fit Contact SLR Integrated handlebar
- Accepts wide range of display sizes and styles
- Designed to accommodate Di2 wiring system



Item
410000031

**\$9<sup>99</sup>**

## CONTACT AERO CLIP-ON CLAMP

- Durable, lightweight alloy clamp system
- Simple one-bolt adjustment
- Wide range of armrest positions



Item
180000071

**\$119<sup>99</sup>**

## CONNECT SL "U" BAR

- Lightweight U-bar to be used with Giant Clip-On clamp system



Item
180000076

**\$199<sup>99</sup>**

## CONNECT SL "S" BAR

- Lightweight carbon bars to be used with Giant Clip-On Clamp system



Item
180000075

**\$99<sup>99</sup>**

## S-TYPE ALLOY BAR

- 22.2mm alloy aerobar extensions
- Compatible with Aero Clip-on clamp



Item
180000116

**\$29<sup>99</sup>**

## CONNECT SL CLIP-ON CLAMP

- Single bolt clamp for easy installation and set up
- Adjustable arm rests adapts to a wide range of positions
- Compatible with regular 31.8 round handlebars



Item
180000072

**\$99<sup>99</sup>**

# STEMS



## CONTACT SLR OD2 CARBON NEW

- Stiff, ultra-light, full-composite oversize box-section increases torsional stiffness with tuned vertical compliance
- 46mm wide alloy faceplate
- Titanium hardware
- Recessed top cap and semi-integrated spacer maximizes stem to steerer contact
- 1-1/8" steerer adapter included

Item	Clamp	Length	Angle	Steerer
170000098	31.8mm	60mm	+/-8	1-1/4
170000099	31.8mm	70mm	+/-8	1-1/4
170000100	31.8mm	80mm	+/-8	1-1/4
170000101	31.8mm	90mm	+/-8	1-1/4
170000102	31.8mm	100mm	+/-8	1-1/4
170000103	31.8mm	110mm	+/-8	1-1/4
170000104	31.8mm	115mm	+/-8	1-1/4
170000105	31.8mm	120mm	+/-8	1-1/4



\$234<sup>99</sup>

## CONTACT SL OD2 NEW

- 3D forged 2014 aluminum alloy with oversized box cross-section
- Oversized 46mm wide 6061 alloy faceplate
- Titanium hardware
- 1-1/8" steerer adapter included



\$89<sup>99</sup>

Item	Clamp	Length	Angle	Steerer	Colour
170000108	31.8mm	60mm	+/-8	1-1/4	BLACK
170000109	31.8mm	70mm	+/-8	1-1/4	BLACK
170000110	31.8mm	80mm	+/-8	1-1/4	BLACK
170000111	31.8mm	90mm	+/-8	1-1/4	BLACK
170000112	31.8mm	100mm	+/-8	1-1/4	BLACK
170000113	31.8mm	110mm	+/-8	1-1/4	BLACK
170000114	31.8mm	115mm	+/-8	1-1/4	BLACK
170000115	31.8mm	120mm	+/-8	1-1/4	BLACK
170000119	31.8mm	60mm	+/-8	1-1/4	WHITE
170000120	31.8mm	70mm	+/-8	1-1/4	WHITE
170000121	31.8mm	80mm	+/-8	1-1/4	WHITE
170000122	31.8mm	90mm	+/-8	1-1/4	WHITE
170000123	31.8mm	100mm	+/-8	1-1/4	WHITE
170000124	31.8mm	110mm	+/-8	1-1/4	WHITE
170000125	31.8mm	115mm	+/-8	1-1/4	WHITE
170000126	31.8mm	120mm	+/-8	1-1/4	WHITE
170000136	31.8mm	70mm	+/-20	1-1/4	BLACK
170000137	31.8mm	80mm	+/-20	1-1/4	BLACK
170000138	31.8mm	90mm	+/-20	1-1/4	BLACK
170000139	31.8mm	100mm	+/-20	1-1/4	BLACK

## CONTACT OD2 NEW

- 3D forged 6061 aluminum alloy body with oversize box cross-section
- Oversized 46mm wide 6061 alloy faceplate
- ±8° rise requires fewer spacers
- 1-1/8" steerer adapter included
- Steel hardware



\$39<sup>99</sup>

Item	Clamp	Length	Angle	Steerer
170000140	31.8mm	60mm	+/-8	1-1/4
170000141	31.8mm	70mm	+/-8	1-1/4
170000142	31.8mm	80mm	+/-8	1-1/4
170000143	31.8mm	90mm	+/-8	1-1/4
170000144	31.8mm	100mm	+/-8	1-1/4
170000145	31.8mm	110mm	+/-8	1-1/4
170000146	31.8mm	120mm	+/-8	1-1/4



## CONTACT SL AM NEW

- Forged 6061 alloy construction
- Compatible with OverDrive (28.6mm) and OverDrive2 (31.8mm) steerers
- 52mm wide clamp for added stiffness
- Smooth, knee-friendly clamp design
- 5-degree rise for long-travel bikes



Item	Clamp	Length
170000130	31.8mm	50mm
170000131	31.8mm	60mm
170000132	31.8mm	70mm

\$89<sup>99</sup>

## CONTACT SL FR NEW

- Durable, light-weight forged 6061 alloy
- 52mm wide clamp for added stiffness
- Smooth, knee-friendly clamp design
- 0° rise for long travel bikes
- Compatible with OverDrive (28.6mm) and OverDrive2 (31.8mm) steerers



Giant#	Clamp	Length
170000133	31.8mm	48mm
170000134	31.8mm	55mm

\$79<sup>99</sup>

## THREADLESS ADJUSTABLE

- 2D forged aluminum stem
- Lightweight, stiff stem for 31.8mm clamp
- 1-1/8" ahead style steer tube
- Includes top cap and bolt
- 0 to 60 degree adjustable rise



\$29<sup>99</sup>

Item	Clamp	Length	Angle	Steerer	Colour
810668	31.8mm	95mm	+/- 7°	1-1/8"	BLACK
810669	31.8mm	110mm	+/- 7°	1-1/8"	BLACK

## CONTACT DH DIRECT MOUNT NEW

- Durable, lightweight forged 6061 alloy
- 52mm wide clamp for added stiffness
- 0-degree rise for long travel bikes
- Adjustable reach
- Compatible with: 2005+ RockShox Boxxer forks, FOX 40 forks, Manitou Dorado forks



Item	Clamp	Length	Angle	Steerer	Weight
170000135	31.8mm	40-50mm	0°	1-1/8"	124g

\$89<sup>99</sup>

## SPACER KITS



Item	Type	Included Sizes	Price
141200	Alloy	2x2.5mm, 1x5mm, 1x10mm	\$5.99
160000000	Carbon	1x2.5mm, 2x5mm, 2x10mm	\$9.99
160000004	Aero Spacer Kit	for Aero Integrated bar	\$34.99

# SEATPOSTS



## CONTACT SL SWITCH REMOTE NEW

- Up to 100mm vertical travel adjustability with limitless positioning
- Anti-Twist Technology keeps the saddle firmly positioned
- Smooth air spring & oil bath cartridge offers consistent load range adjustment
- Interchangeable clamp design for standard 7mm (alloy) or 9mm (composite) saddle rails
- Reversible outer clamp design allows for 12mm or 23mm offset options

Item	Diameter	Offset	Length
150000034	30.9mm	12/23mm	350mm
150000035	30.9mm	12/23mm	375mm
150000036	30.9mm	12/23mm	400mm

**\$259<sup>99</sup>**

### CONTACT SWITCH PARTS

Item	Part	Length	Price
150000024	Cartridge	350mm	\$59.99
150000026	Cartridge	375mm	\$59.99
150000025	Cartridge	400mm	\$59.99
150000027	Cable Set		\$29.99
150000028	Clamp Set		\$19.99



## CONTACT SLR NEW

- Single piece molded composite shaft and head
- Alloy rail clamp reverses between 12mm and 23mm offsets
- Extra long lower rail clamp is friendly with lightweight rails

Item	Diameter
150000031	27.2mm

**\$149<sup>99</sup>**



## VECTOR ADVANCED CARBON ZERO OFFSET

- Replacement seatpost for all 09+ non-ISP TCR, Defy, and Avail Composite, Advanced and Advanced SL bikes
- 0mm offset

Item	Diameter	Length	Offset
150000013	VECTOR	350mm	0mm

**\$169<sup>99</sup>**



## CONTACT SL/ ZERO OFFSET NEW

- 3D forged single piece alloy shaft and head
- 12/23mm or zero offset
- Extra long lower rail clamp is friendly with lightweight rails

Item	Diameter	Length	Offset
150000032	30.9mm	400mm	12/23mm
150000033	30.9mm	400mm	0mm

**\$84<sup>99</sup>**



## CONTACT COMPOSITE NEW

- Spiral wound, unidirectional composite shaft bonded to 2D forged 6061 alloy head
- Reversible outer clamp design allows for 12mm or 23mm offset options
- Extra long lower saddle rail guide designed to cradle lightweight saddle rails

Item	Diameter	Length
150000037	30.9mm	400mm
150000038	27.2mm	400mm

**\$49<sup>99</sup>**



## CONNECT NEW

- 6061 alloy shaft bonded to 2D forged 6061 alloy head
- Extra long lower rail clamp is friendly with lightweight rails

Item	Diameter	Length
150000039	30.9mm	400mm
150000040	27.2mm	400mm

**\$24<sup>99</sup>**



# SADDLES



## CONTACT SADDLE



- Dynamic Forward/Upright riding positions
- Gender specific profile and center channel
- Durable synthetic leather cover with HD fill for comfort
- Lightweight LF fill with Particle Flow Technology

Item	Position	Colour	Weight
120000011	FORWARD	BLACK/GRAY	325g
120000012	FORWARD	BLACK/BLUE	325g
120000014	UPRIGHT	BLACK/WHITE	310g
120000015	UPRIGHT	BLACK/BLUE	310g



\$44<sup>99</sup>

## CONNECT SADDLE

- Dynamic Forward/Upright riding positions
- Gender specific profile and center channel
- Durable synthetic leather cover
- Lightweight LF fill with Particle Flow Technology

Item	Position	Colour	Weight
120000016	FORWARD	BLACK/GRAY	315g
120000017	FORWARD	BLACK/WHITE	315g
120000018	UPRIGHT	BLACK/GRAY	315g
120000020	UPRIGHT	BLACK/BLUE	315g



\$34<sup>99</sup>



## FLOW 1 SADDLE

- Seamless all-weather Micro-fiber top
- Lightweight chromoly rails
- Lightweight foam padding
- ZONE full-cut pressure relief

Item  
771100



\$39<sup>99</sup>



## FLOW 2 SADDLE

- Seamless all-weather Micro-fiber top
- Lightweight chromoly rails
- Lightweight foam padding
- ZONE plus multi-density pressure relief

Item  
771102



\$29<sup>99</sup>

## CONTACT COMFORT+



- Lightweight, water-resistant seamless synthetic cover
- Pressure relief D2 base
- Tough, durable Chromoly rails

Item  
120000029



\$39<sup>99</sup>

## CONNECT COMFORT+



- Optimized design for shorter distance riding
- Lightweight, water-resistant seamless synthetic cover
- Center Zone Cut
- Steel rails

Item  
120000031



\$29<sup>99</sup>

## CONTACT CITY+ UNISEX



- Center Zone Cut
- Lightweight, water-resistant seamless synthetic cover
- Pressure relief D2 base
- Tough, durable Chromoly rails

Item  
120000033



\$39<sup>99</sup>

## CONNECT CITY UNISEX



- Lightweight, water-resistant synthetic cover
- Steel rails

Item  
120000035



\$29<sup>99</sup>

# HANDLEBAR TAPE



## SLR

- Washable half-perforated surface
- Includes Giant logo end plugs and Giant finishing tape
- Integrated EVA absorbs shock for increased comfort

Item	Material	Colour
190000033	SYNTHETIC	BLACK/WHITE
190000034	SYNTHETIC	WHITE/BLACK
190000035	SYNTHETIC	BLUE/WHITE
190000036	SYNTHETIC	RED/WHITE



\$24<sup>99</sup>

## CONTACT GEL

- Embossed Giant logo
- Non slip synthetic suede surface
- Anti-vibration Gel absorbs shock for increased comfort
- Includes Giant logo end plugs and Giant finishing tape

Item	Material	Colour
190000028	GEL	BLACK
190000029	GEL	WHITE
190000030	GEL	BLUE
190000031	GEL	RED



\$19<sup>99</sup>

## CONNECT GEL NEW

- Anti vibration Gel absorbs shock for increased comfort
- Multiple color options
- Includes Giant logo end plugs and Giant finishing tape

Item	Material	Colour
190000021	GEL	BLACK
190000022	GEL	WHITE
190000023	GEL	BLUE
190000024	GEL	RED



\$14<sup>99</sup>

## GRIPS



### SOLE-O LOCK-ON MTB

- Made from soft and durable Kraton rubber
- Custom waved raised surface

Item	Colour	Price
<b>DOUBLE LOCK-ON</b>		
190000057	BLACK	\$24.99
190000058	WHITE	\$24.99
190000059	BLUE	\$24.99
190000060	RED	\$24.99
<b>SINGLE LOCK-ON</b>		
410956	BLACK/BLACK LOCK	\$19.99
410965	BLACK/RED LOCK	\$19.99
410967	WHITE/BLACK LOCK	\$19.99
190000066	BLACK/WHITE LOCK	\$19.99
190000067	BLUE/WHITE LOCK	\$19.99
190000068	DK BLUE/WHITE LOCK	\$19.99
190000069	GRAY/WHITE LOCK	\$19.99



### XC LOCK-ON MTB

- Made from soft durable Kraton rubber
- Custom anatomic raised surface

Item	Colour	Price
<b>DOUBLE LOCK-ON</b>		
190000064	BLACK	\$24.99
190000065	WHITE	\$24.99
<b>SINGLE LOCK-ON</b>		
410940	BLACK/BLACK	\$19.99
410941	BLACK/BLUE	\$19.99
410942	BLACK/RED	\$19.99



### DOUBLE DENSITY LOCK-ON

- Aluminum or plastic lock-on rings provide convenient installation and removal
- Double density soft kraton rubber construction provides excellent shock absorption
- Diamond shaped surface pattern provides control in all conditions

Item	Colour	Type	Price
410751	BLACK	ALLOY LOCK-ON	\$18.99
410752	BLACK	PLASTIC LOCK-ON	\$14.99



### XC SL MTB

- Made from soft durable Kraton rubber
- Custom anatomic raised surface

Item	Length	Colour	Price
410900	135mm	BLACK	\$14.99
410939	135mm	WHITE	\$14.99



### CONNECT ERGO MAX PLUS

- Integrated alloy bar end offers multiple hand positions and increased leverage
- Custom ergonomic profile for increased rider comfort
- Co-molded, durable Kraton rubber with softer material in critical comfort areas
- Non-slip knurled surfaces for use in all conditions
- Lock-on design

Item	Type	Length	Colour	Price
411200	LOCK-ON	125mm	BLACK/GREY	\$39.99



### CONNECT ERGO MAX LOCK-ON

- Custom ergonomic profile for increased rider comfort
- Co-molded, durable Kraton rubber with softer material in critical comfort areas
- Non-slip knurled surfaces for use in all conditions
- Lock-on design

Item	Type	Length	Colour	Price
411204	LOCK-ON	125mm	BLACK/GREY	\$29.99





### CONNECT ERGO MAX

- Custom ergonomic profile for increased rider comfort
- Co-molded, durable Kraton rubber with softer material in critical comfort areas
- Non-slip knurled surfaces for use in all conditions

Item	Length	Colour	Price
411202	125mm	BLACK/GREY	\$18.99



### DUAL DENSITY ERGO

- Dual-Density in Kraton and gel insert
- Ergonomic shape for comfort support and handling
- Includes end-caps

Item	Colour	Price
410609	BLACK/GREY	\$12.99



### SOLE-O BMX

- Made from soft and durable Kraton rubber
- Custom waved raised surface

Item	Length	Colour	Price
410948	140mm	BLACK	\$12.99
410961	140mm	BLUE	\$12.99
410954	140mm	GREY	\$12.99
410955	140mm	NEON GREEN	\$12.99

## BAR ENDS



### CONTACT ALUMINUM

- 3D forged aluminum construction
- Rubberized thumb plate
- Triangulated shape for maximum comfort
- Durable anodized finish

Item	Colour	Price
450711	BLACK	\$19 <sup>99</sup>
450712	SILVER	



### CONTACT ERGO

- Ergonomic profile offers maximum comfort
- Rubberized surface provides extreme grip
- Stainless steel hardware

Item	Price
450709	\$19 <sup>99</sup>

# PEDALS



## ORIGINAL MTB - SPORT

- Scallop Shape provides extra grip and a stable platform
- Low profile design
- 10 replaceable and adjustable pins per side
- Sealer Bearings
- Cro-Mo axle

Item	Axle	Colour
230000011	9/16"	BLACK
230000012	9/16"	WHITE



\$49<sup>99</sup>

## REPLACEMENT PIN AND TOOL - MTB

- For use on Original MTB Pedal Sport/Core

Item
230000028

\$9<sup>99</sup>



## AC PEDAL

- Ultra light 235g per pair
- Aluminum cage and body
- Toe clip/strap compatible
- Cr Mo Axle
- Ball bearing

Item	Axle	Colour
230000006	9/16"	BLACK
230000007	9/16"	SILVER

\$24<sup>99</sup>



## TOE CLIP FOR AC PEDAL

- Add-on toe clips for AC pedals
- Medium or large

Item	Colour
230000026	MEDIUM
230000027	LARGE

\$12<sup>99</sup>



## ORIGINAL MTB - CORE

- Scallop Shape provides extra grip and a stable platform
- Low profile design
- 10 replaceable and adjustable pins per side
- Giant original Laser-etched pattern

Item	Axle	Colour
230000013	9/16"	BLACK
230000014	9/16"	WHITE
230000015	9/16"	RED
230000016	9/16"	BLUE



\$39<sup>99</sup>



## CITY PEDAL - SPORT

- Durable aluminum body
- Ball bearing

Item	Axle
230000022	9/16"

\$22<sup>99</sup>



## CITY PEDAL - CORE

- Plastic body
- Ball bearing

Item	Axle
230000023	9/16"

\$12<sup>99</sup>



## PLATFORM PLASTIC

- Tough and durable reinforced Nylon body
- Variety of colors
- Low profile design

Item	Axle	Colour
230000017	9/16"	BLACK
230000018	9/16"	WHITE
230000019	9/16"	RED
230000020	9/16"	LIGHT GREEN
230000021	9/16"	PURPLE

\$24<sup>99</sup>



## ATB W/TOE CLIP

- Resin black body
- Alloy cage in silver
- Resin toe-clip w/large toe box & strap
- Steel 9/16" axle

Item	Axle
670915	9/16"

\$22<sup>99</sup>



## NYLON MTB

- Nylon composite body
- 9/16" steel axle
- Includes reflectors

Item	Axle
670576	9/16"

\$8<sup>99</sup>



## PLASTIC JUVENILE

- 1/2" steel axle
- Includes reflectors

Item	Axle
670767	1/2"

\$7<sup>99</sup>



## LIL GIANT TRIKE

- Classic replacement juvenile pedals
- Steel axle and body with rubber grip blocks

Item	Axle	Colour
670303	1/2"	BLACK/SILVER

\$14<sup>99</sup>



## TOE-CLIP/STRAP SET

- Composite double arm construction
- Large toe box to accommodate variety of shoe sizes
- Braided Nylon toe clip strap

Item	Size
670805	LARGE
670806	MEDIUM

\$9<sup>99</sup>





## P-SLR1

- Front and rear specific tread compounds
- High volume casing for comfort and performance
- Deflect 2 lightweight puncture resistant Kevlar belt under the tread
- Built-in wear indicator

Item	Size	Usage	Bead	PSI	Flat Protection	Price
340000003	700x23	FRONT	KEVLAR	120	DEFLECT 2	\$54.99
340000004	700x23	REAR	KEVLAR	120	DEFLECT 2	\$54.99
340000123	700x25	FRONT	KEVLAR	120	DEFLECT 2	\$54.99
340000124	700x25	REAR	KEVLAR	120	DEFLECT 2	\$54.99



## P-SLR2

- Front and rear specific tread compounds
- High volume casing for comfort and performance
- Deflect 2 lightweight puncture resistant Kevlar belt under the tread
- Built-in wear indicator

Item	Size	Usage	Bead	PSI	Flat Protection	Price
340000019	700x23	FRONT	KEVLAR	120	DEFLECT 2	\$49.99
340000020	700x23	REAR	KEVLAR	120	DEFLECT 2	\$49.99
340000027	700x25	FRONT	KEVLAR	120	DEFLECT 2	\$49.99
340000028	700x25	REAR	KEVLAR	120	DEFLECT 2	\$49.99



## P-SL2

- Front and rear specific tread compounds
- High volume casing for comfort and performance
- Deflect 2 lightweight puncture resistant Kevlar belt under the tread
- Built-in wear indicator

Item	Size	Usage	Bead	PSI	Flat Protection	Price
340000037	700x23	FRONT	KEVLAR	120	DEFLECT 2	\$39.99
340000038	700x23	REAR	KEVLAR	120	DEFLECT 2	\$39.99
340000039	700x25	FRONT	KEVLAR	120	DEFLECT 2	\$39.99
340000040	700x25	REAR	KEVLAR	120	DEFLECT 2	\$39.99



## P-R3

- Front and rear specific tread compounds
- High volume casing for comfort and performance
- Deflect 3 nylon breaker belt under the tread
- Built-in wear indicator

Item	Size	Usage	Bead	PSI	Flat Protection	Price
340000047	700x23	FRONT	WIRE	120	DEFLECT 3	\$29.99
340000048	700x23	REAR	WIRE	120	DEFLECT 3	\$29.99
340000055	700x25	FRONT	WIRE	120	DEFLECT 3	\$29.99
340000056	700x25	REAR	WIRE	120	DEFLECT 3	\$29.99
340000063	700x28	FRONT	WIRE	120	DEFLECT 3	\$29.99
340000064	700x28	REAR	WIRE	120	DEFLECT 3	\$29.99



## P-R1 ALL CONDITION

- Front and rear specific rubber compound
- Fast rolling, stable tread design in any on-road condition
- Folding bead

Item	Size	Usage	Bead	PSI	Price
340000133	700x25C	FRONT	WIRE	120	\$49.99
340000134	700x25C	REAR	WIRE	120	\$49.99
340000135	700x28C	FRONT	WIRE	120	\$49.99
340000136	700x28C	REAR	WIRE	120	\$49.99



## P-R3 ALL CONDITION

- Front and rear specific tread rubber compound
- Fast rolling and stable tread design in any on-road condition
- Oversized casing design for better comfort
- Wire bead

Item	Size	Usage	Bead	PSI	Flat Protection	Price
340000073	700x25C	FRONT	WIRE	120	DEFLECT 3	\$39.99
340000074	700x25C	REAR	WIRE	120	DEFLECT 3	\$39.99
340000075	700x28C	FRONT	WIRE	120	DEFLECT 3	\$39.99
340000076	700x28C	REAR	WIRE	120	DEFLECT 3	\$39.99





## S-R3 ALL CONDITION

- Fast rolling, stable tread design in any condition
- Reflective sidewall increases visibility
- Wire bead
- Deflect 4 puncture protection

Item	Size	Usage	Bead	PSI	Flat Protection	Price
340000082	700x25C	FRONT OR REAR	WIRE	120	DEFLECT 4	\$29.99
340000083	700x28C	FRONT OR REAR	WIRE	120	DEFLECT 4	\$29.99
340000084	700x32C	FRONT OR REAR	WIRE	85	DEFLECT 4	\$29.99



## P-SLX2 ANY ROAD

- Excellent choice for city use or dry cyclocross conditions
- Wire bead
- Deflect 2 puncture protection
- Built-in wear indicator

Item	Size	Usage	Bead	PSI	Flat Protection	Price
340000093	700x32C	FRONT OR REAR	WIRE	75	DEFLECT 2	\$49.99
340000094	700x35C	FRONT OR REAR	WIRE	75	DEFLECT 2	\$49.99



## P-RX2 ANY ROAD

- Tread design offers improved traction and stability on loose or rough surfaces
- Excellent choice for city use or dry cyclocross conditions
- Wire bead
- Deflect 2 puncture protection

Item	Size	Usage	Bead	PSI	Flat Protection	Price
340000095	700x32C	FRONT OR REAR	WIRE	75	DEFLECT 2	\$39.99
340000096	700x35C	FRONT OR REAR	WIRE	75	DEFLECT 2	\$39.99
340000097	700x40C	FRONT OR REAR	WIRE	75	DEFLECT 2	\$39.99



## P-X1

- Abrasion resistant low-density nylon sidewalls
- Built-in wear indicator
- Reflective sidewalls

Item	Size	Bead	PSI	Price
340000088	700x32C	WIRE	65	\$39.99
340000089	700x35C	WIRE	65	\$39.99



## SPORT 27.5

- Durable 30 TPI casing
- Tread pattern functions well on cycling paths or trails

Item	Size	Usage	Bead	PSI	Flat Protection	Price
340000122	27.5x2.1	FRONT OR REAR	WIRE		DEFLECT 2	\$29.99
340000121	27.5x1.95	FRONT OR REAR	WIRE		DEFLECT 2	\$29.99



## P-X2

- Anti-abrasion sidewalls and kevlar belt
- Built-in wear indicator
- Reflective sidewall increases visibility
- Wire bead
- Deflect 4 Puncture Protection

Item	Size	Bead	PSI	Flat Protection	Price
340000090	700x32C	WIRE	65	DEFLECT 4	\$28.99
340000091	700x35C	WIRE	65	DEFLECT 4	\$28.99



# LOCKS



## FOLDING 1 NEW

- Strong links covered with a soft coating to prevent scratches
- 5mm hardened steel bars are linked with special rivets
- Link construction allows compact folding
- Includes 2 keys
- Included case for storing lock and attaching on bike



Item  
520000051

\$69<sup>99</sup>

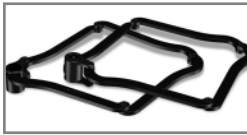

## FOLDING 2 NEW

- Strong links covered with a soft coating to prevent scratches
- 3mm hardened steel bars are linked with special rivets
- Link construction allows compact folding
- Includes 2 keys
- Included case for storing lock and attaching on bike



Item  
520000052

\$59<sup>99</sup>



## SURELOCK PROTECTOR 1 NEW

- X4P Quattro bolt locking mechanism provides unequal strength
- Massive 14mm (0.55") ultra-hardened-steel shackle provides maximum cut-resistance
- M-Key cylinder is more reliable and user-friendly than ever before, prevents key from turning before being fully inserted into the cylinder
- QR mounting bracket
- included-fits 24-40mm tubes
- Micro-light key projects a highly focused white light beam
- Integrated dust cover protects the cylinder
- Includes 5 keys



Item	Type	Size	Price
520000000	DOUBLE TIME	14mmx230mm/ 10mmx120mm CABLE	\$54.99
520000002	LONG SHACKLE	14mmx292mm	\$49.99
520000001	STANDARD	14mmx230mm	\$44.99



## SURELOCK PROTECTOR 2

- X2P double bolt locking mechanism provides stable strength and high pull resistance
- Massive 13mm (0.51") ultra-hardened steel shackle provides maximum cut-resistance
- M-Key cylinder is more reliable and user-friendly than ever before, prevents key from turning before being fully inserted into the cylinder
- QR mounting bracket included – fits 24-40mm tubes
- Integrated dust cover protects cylinder
- Includes 5 keys

Item	Type	Size	Price
520000003	DOUBLE TIME	13mmx230mm/ 10mmx120cm cable	\$39.99
520000005	LONG SHACKLE	13mmx292mm	\$34.99
520000004	STANDARD	13mmx230mm	\$29.99



## SURELOCK FLEX 15 - COMBO

- Extra-flexible cable with integrated re-settable combo lock
- Zinc caps offer more protection against attacks
- Tough vinyl cover protects against scratches
- 4 fluorescent digits; set your own combination—no keys to lose or forget (10,000 variations)
- Includes handy straps for compact carry and mount bracket



Item	Type	Size
520000015	COMBO	15mmx185cm

**\$29<sup>99</sup>**

## SURELOCK TOUGH 1

- X2P double-bolt locking mechanism provides strength and high pull resistance
- M-Key cylinder prevents key from turning before being fully inserted
- Zinc caps offer more protection against impact attacks
- Automatic dust cover protects lock cylinder
- Hardened steel shells protect twisted steel cable and a tough vinyl outer sleeve protects against scratches



**\$39<sup>99</sup>**

Item	Type	Size
520000008	KEY	25mmx120cm

## SURELOCK FLEX 15 - KEY

- X2P double bolt locking mechanism for stable security
- Extra-flexible, self-coiling cable with integrated lock
- Tough vinyl cover protects against scratches
- Zinc caps offers more protection against attacks
- Easy-to-use quick release bracket (included)
- High security, pick and drill resistant lock cylinder with automatic dust cover protects lock cylinder
- Includes 5 keys (1 micro-light and 4 extra keys)



Item	Type	Size
520000010	KEY	15mmx185cm

**\$26<sup>99</sup>**

## SURELOCK FLEX 8

- Tough vinyl cover protects against scratches
- 4 digits, set your own combination
- Includes mount bracket

Item	Colour	Type	Size	Price
520000037	BLACK	COMBO	8mm	\$19.99
520000038	PURPLE	COMBO	8mm	\$19.99
520000032	BLACK	KEY		\$16.99
520000033	PURPLE	KEY		\$16.99



## SURELOCK TWIST BRACKET

- Easy-to-use quick release bracket
- For use with Surelock Flex and U-Locks

Item	Type	Price
520000023	U-LOCK	\$8.99
520000024	CABLE LOCK	\$6.49



# INDOOR TRAINERS



## CYCLOTRON FLUID COMP

Don't let the weather or a busy schedule get in the way of your fitness. Giant's Cyclotron Fluid Comp Trainer will keep you spinning year-round.

- Real Road Simulation (RRS) technology provides up to 2000 watts of quiet, smooth, progressive resistance
- TurboTron 70mm alloy roller with internal cooling fins reduces heat build up and prolongs tire life
- F4 fluid formed alloy frame provides incredible stiffness
- Dial-adjust anti-skid feet keep your trainer stable and your floors clean
- Accommodates most wheels from 24" to 29"
- Pre-loading coupler and torque set knob allow for easy bike installation and removal
- 17.6lb flywheel for improved road feel
- Includes riser block



Item	Adj. Resistance	Colour	Price
931101	NO	WHITE/SILVER	\$449.99



## CYCLOTRON FLUID ST

- Real Road Simulation (RRS) technology provides up to 2000 watts of quiet, smooth, progressive resistance
- TurboTron 70mm alloy roller with internal cooling fins reduces heat build up and prolongs tire life
- F4 fluid formed alloy frame provides incredible stiffness
- Dial-adjust anti-skid feet keep your trainer stable and your floors clean
- Accommodates most wheel from 24" to 29"
- 7.5lb flywheel for improved road feel

Item	Adj. Resistance	Colour	Price
931107	NO	SILVER	\$379.99



## CYCLOTRON AUTO MAG

- Progressive magnetic resistance automatically gives a wide range of resistance from easy spins to burning climbs with no remote adjuster
- 100% aluminum Grey anodized I-Beam frame is stellar looking and rust-resistant
- Non-skid rubber adjustable leveling feet
- Precision-turned 2" aluminum roller and 1500g (3.3lbs) flywheel are mounted to a stiff, die-cast aluminum carrier for smooth pedaling action
- Tough steel replacement quick-release skewer included
- Accommodates most wheel/tire sizes 29", 27", 700C, and 26"

Item	Adj. Resistance	Colour	Price
930605	AUTO	GREY	\$299.99



## CYCLOTRON MAG

- Quiet magnetic unit with 7 resistance levels activated by handlebar mounted thumb shifter
- Handlebar mounted, 7-level thumb shifter, quickly mounts on handlebars from 22.2mm (7/8") up to 31.8mm (1 1/4")
- Precision-turned 2" aluminum roller and 1500g (3.3lbs) flywheel
- Heavy-duty, 100% steel, TIG welded frame with wide stance and tough powder coating that looks great and resists rust
- Non-skid rubber adjustable leveling feet
- Tough steel replacement quick-release skewer included
- Accommodates most 24", 26", 700C, and 27" wheel/tire sizes

Item	Adj. Resistance	Colour	Price
930601	YES	WHITE	\$229.99



## TRAINER MAT

- Rubberized material for easy rinse off after your workout
- 'Pebbled' surface, anti-skid and scratch-resistant material protects flooring while working out
- Extra-large 3' x 6' (91.5cm x 183cm) size covers entire workout area, prevents perspiration from getting on carpets or wood floors
- Comes rolled-up in draw-string, mesh carry bag with shoulder strap

Item	Colour	Price
930503	BLACK	\$49.99



## RISER BLOCK

- For a stable, worry free ride in any rear mounted trainer
- Compatible with 26/700C wheels
- Anti-skid base

Item	Colour	Price
930501	BLACK	\$15.99



## SWEAT BLOCKER

- Terry cloth sweat-stopper, Sweat Net, Bike-Thong... we call it a G-Thang

Item	Colour	Price
930504	BLACK	\$19.99

## TRAINER SERVICE PARTS

Item	Description	Price
930403	930403 CYCLOTRON MAG TRAINER CONTROL CLAMP	\$13.99
930405	930405 CYCLOTRON MAG TRAINER CABLE	\$7.99
930407	930407 CYCLOTRON MAG TRAINER Q/R LEVER	\$19.99

# LIGHTS



## NUMEN AERO/AERO+ LED HEADLIGHT

See and be seen after dark with this super bright aerodynamic light. With five bright LED bulbs and three modes the Numen Aero/Aero+ is sure to extend your available riding time.

- Aero+ is USB rechargeable and includes 3 rechargeable batteries
- Five bright LEDs
- High/mid/flashing modes
- Easy, low profile center of handlebar mount
- Water resistant rubber and plastic housing



Item	Name	Burn Time	Batteries	Colour	Price
571105	AERO+	UP TO 50 HRS	3 AAA RECHARGEABLE	BLACK	\$39.99
571104	AERO	UP TO 50 HRS	3 AAA	BLACK	\$29.99



## NUMEN AERO+ TAILLIGHT

- 3 SMD LEDs
- 3 modes: Steady (2hrs)/Flash (4hrs)/Patrol (6hrs)
- Li-ion Rechargeable battery via Micro USB port
- Low battery indicator



Item  
400000032

\$34<sup>99</sup>

## NUMEN AERO TAILLIGHT

- 3 LED, aerodynamic taillight
- Designed for ISP/ aero seatposts
- 3 modes: Steady/ Flashing/Chasing
- Easy o-ring mount
- Water resistant rubber and plastic housing



Item	Burn Time	Batteries
571106	UP TO 90 HRS	2 CR2032

\$19<sup>99</sup>

## NUMEN AERO ISP MOUNT

- Rubberized mount fits into existing Numen Aero mount - for secure attachment to ISP frames



Item  
400000014

\$4<sup>99</sup>

## NUMEN+ SPARK NEW

- HL: 16 Super bright white LEDs  
TL: 30 Super bright red LEDs
- Modes: Overdrive (1.5hrs)/ Steady (4.5hrs)/ Flash (5hrs)/ Strobe (5.5hrs)/ Pulse (6hrs)
- Li-ion rechargeable battery via Micro USB
- HL: 80 Lumens, TL: 30 Lumens
- User friendly rubber strap mounting design



Item	Type	Colour
400000094	HEADLIGHT	BLACK
400000095	HEADLIGHT	WHITE
400000096	TAILLIGHT	BLACK
400000097	TAILLIGHT	WHITE

\$44<sup>99</sup>

## NUMEN+ CLICK NEW

- 1 Super bright White(HL)/Red(TL) LED
- Modes: Steady (3hrs)/ Flash (50hrs)
- Li-ion rechargeable battery via Micro USB
- HL: 40 Lumens, TL: 15 Lumens
- User friendly rubber strap mounting design

### HEADLIGHT

Item	Colour
400000062	BLACK
400000063	SILVER
400000064	BLUE
400000065	RED
400000066	GRAY
400000067	PINK



\$39<sup>99</sup>

### TAILLIGHT

Item	Colour
400000068	BLACK
400000069	SILVER
400000070	BLUE
400000071	RED
400000072	GRAY
400000073	PINK



\$39<sup>99</sup>

## NUMEN+ HL1

- 2W headlight with High power Creed LED
- Modes: High (6hrs) /Mid (12hrs)/Flash (30hrs)/Strobe (30hrs)/Police Flash (30hrs)
- Aluminum body
- Li-ion Rechargeable Battery via Mirco USB
- Power indicator

Item	Batteries
400000024	INTERNAL

**\$84<sup>99</sup>**



## NUMEN+ HL1.5 NEW

- 1W super bright LED
- Modes: High (3hrs)/Mid (6hrs)/Flash (25hrs)
- Low battery indicator
- Charge time: 1.5hrs
- 115 Lumens
- Li-ion rechargeable battery via Micro USB
- User friendly mounting system

Item	Batteries
400000045	INTERNAL

**\$59<sup>99</sup>**



## NUMEN+ HL2

- 4 Lamp LEDs
- 15 LUX compact headlight
- Modes: High (3hrs)/Mid (6hrs) /Flash (12hrs)
- Rechargeable Battery via mirco USB
- Low battery indicator

Item	Batteries	Colour
400000025	INTERNAL	BLACK
400000026	INTERNAL	WHITE

**\$34<sup>99</sup>**



## NUMEN HL2

- 2 LUX headlight
- 5 Lamp LEDs
- Modes: High (40hrs) /Mid (50hrs) /Flash (120hrs)
- 3 AAA Batteries included
- Low battery indicator

Item	Batteries	Colour
400000029	3 AAA	BLACK
400000030	3 AAA	WHITE

**\$24<sup>99</sup>**



## NUMEN COMBO

- 5x LEDs 2 LUX@10m /5x LEDs
- 3x/2x AAA Battery
- Numen HL2 Modes: High, Mid, Flash
- Numen TL1 Modes: Steady, Flash, Patrol, Random

Item
400000031

**\$39<sup>99</sup>**



## NUMEN MINI COMBO NEW

- 2 Bright LEDs
- 2 Modes: Steady/Flash
- Easy mount soft strap
- Water resistant rubber case

Item
400000040

**\$24<sup>99</sup>**



## NUMEN MINI

- 2 Bright LEDs
- 2 Modes: Steady/Flash
- Easy mount soft strap
- Water resistant rubber case

Item	Type	Colour	Price
400000001	FRONT	BLACK	\$14.99
400000002	FRONT	WHITE	\$14.99
400000003	FRONT	RED	\$14.99
400000004	FRONT	BLUE	\$14.99
400000005	FRONT	GREEN	\$14.99
400000006	FRONT	PURPLE	\$14.99
Item	Type	Colour	Price
400000007	REAR	BLACK	\$14.99
400000008	REAR	WHITE	\$14.99
400000009	REAR	RED	\$14.99
400000010	REAR	BLUE	\$14.99
400000011	REAR	GREEN	\$14.99
400000012	REAR	PURPLE	\$14.99



## NUMEN+ TL1 TAILLIGHT NEW

- 5 Super bright LEDs
- Modes: Steady (4hrs) /2Sides (5hrs)/Flash (15hrs)/Pulse (15hrs) /Patrol (30hrs)
- Li-ion rechargeable battery via Micro USB
- Tool-free mounting

Item	Batteries
400000033	INTERNAL

**\$44<sup>99</sup>**



## NUMEN+ TL2.0 TAILLIGHT NEW

- 0.5W Super bright LEDs
- Modes: High (4hrs)/Mid (15hrs)/Flash (45hrs)/Pulse (15hrs)/Random (55hrs)
- Charge time: 1.5hrs
- Li-ion rechargeable battery via Micro USB
- User friendly mounting system

Item	Batteries
400000046	INTERNAL

**\$39<sup>99</sup>**



## NUMEN TL3.0

- 1 high power LED + 6 bright LEDs
- 4 modes: steady /flashing/chasing /random
- Vertical or horizontal tool-free mounting
- Water resistant

Item	Burn Time	Batteries
571003	UP TO 180HRS	2 AAA

**\$25<sup>99</sup>**



## NUMEN TL1 TAILLIGHT

- 5 LEDs Taillight
- 2 AAA Battery included
- Modes: Steady (40hrs)/Flash (80hrs) /Patrol (200hrs) /Random (200hrs)
- Alternative mounting positions possible

Item	Batteries
400000034	INTERNAL

**\$14<sup>99</sup>**



## NUMEN+/NUMEN CLICK RUBBER STRAP NEW

- Replacement strap for attachment to bicycle

Item	Type
400000074	HEADLIGHT
400000075	TAILLIGHT

**\$4<sup>99</sup>**



## NUMEN HEADLIGHT MOUNT

- Replacement mount for Numen headlights (Not Numen Mini)

Item
400000041

**\$4<sup>99</sup>**



## NUMEN TAILLIGHT MOUNT

- Replacement mount for Numen taillights (Not Numen Mini)

Item
400000042

**\$4<sup>99</sup>**



## NUMEN+ AERO TL O-RING

- Replacement band for Numen Plus Aero TL

Item
400000043

**\$2<sup>99</sup>**



## C-CLIP FOR NUMEN TAILLIGHT NEW

Item
400000044

**\$3<sup>99</sup>**

## TAILLIGHT ADAPTER PADS NEW

Item	Type
400000049	D-FUSE
400000047	ISP/PROPEL
400000048	AERO

**\$4<sup>99</sup>**



# COMPUTERS



## NEOS SYNC

ANT+ digital wireless computer with PC-link, optional heart rate belt and speed/cadence sensor allows riders to track their data and integrate with Giant RideSense.

- Computer connects to smartphone or as a stand alone unit (sensor not included)
- RideSense compatible
- User friendly setup process
- Pre-set Wheel Size (10 major wheel sizes)
- Smart Backlight (light sensor detect)
- Rechargeable battery
- ios only



Item  
410000047

**\$129<sup>99</sup>**

## NEOS COMPUTER

ANT+ digital wireless computer with PC-link, optional heart rate belt and speed/cadence sensor allows riders to track their data and integrate with Giant RideSense.

- ANT+ 2.4GHz digital wireless multi-function computer
- PC-linked data analysis
- RideSense Compatible
- Neos Pro+ Includes Giant ANT+ heart rate belt
- Compatible with 3rd party ANT+ compliant power devices
- Smart backlight



Item  
410000046

**\$69<sup>99</sup>**

## AXACT 9W

- 9 function wireless cycling computer
- Easy coin-release battery cap
- Simple low battery indicator
- Auto Start/Stop/Sleep
- Calorie consumption calculation

Item	Colour
410000004	BLACK
410000005	WHITE

**\$39<sup>99</sup>** 



## AXACT 13W

- 13 function wireless cycling computer
- Easy coin-release battery cap
- Simple low battery indicator
- Auto Start/Stop/Sleep
- Calorie consumption calculation
- User-friendly pace setting

Item	Colour
410000006	BLACK

**\$49<sup>99</sup>** 



## AXACT 6 WIRED

- 6 function wired cycling computer
- Easy coin-release battery cap
- Simple low battery indicator
- Auto Start/Stop/Sleep
- Calorie consumption calculation

Item  
410000003

**\$24<sup>99</sup>** 



## CONTINUUM SYNC NEW

ANT+ digital wireless computer with PC-link, optional heart rate belt and speed/cadence sensor allows riders to track their data and integrate with Giant RideSense.

- Computer connects and displays information from smartphone
- Big display screen with LED backlight
- User friendly setup process/ APP setup
- Pre-set Wheel Size (10 major wheel sizes)
- Phone miss call reminder
- Must operate with smartphone (ios only)



Item	Colour
410000069	BLACK
410000070	WHITE

**\$64<sup>99</sup>**

## CONTINUUM 9W

Easy to install, easy to use, and available in four trendy colours to match any Giant Bicycle—the Continuum 9 is the perfect computer for your fashion conscious customers who know quality and expect performance.

- 9 function wireless computer:
  - Speed, distance, ride time, average speed, max speed, alarm, odometer, calorie, clock
- Large, easy-to-read display
- Low battery indicator
- Back light



Item	Colour
291003	BLACK
291004	WHITE
291005	BLUE
291006	PINK

**\$39<sup>99</sup>**

## CONTINUUM 7 WIRED

- 7 function wired computer:
  - Speed, distance, ride time, alarm, odometer, calorie, clock
- Large, easy-to-read display
- Low battery indicator



Item	Colour
291001	BLACK
291002	WHITE

**\$24<sup>99</sup>**

## CONTACT SLR INTEGRATED MOUNT

- Designed to fit Contact SLR Integrated handlebar
- Designed to accommodate Di2 wiring system
- Accepts wide range of display sizes and styles



Item
410000031

**\$9<sup>99</sup>**

## AXACT WIRELESS MOUNT KIT

- Includes Sensor + Magnet

Item
410000033

**\$24<sup>99</sup>**



## AXACT WIRED MOUNT KIT

- Includes Sensor + Magnet

Item
410000032

**\$13<sup>99</sup>**



## COMPUTER ACCESSORIES

Item	Name	Price
410000055	MY15 RIDESENSE ANT+/BLU	\$49.99
291132	HR BELT	\$69.99
291133	2IN1 SENSOR + MAGNETS	\$39.99
291134	MOUNT PACK	\$14.99
291135	RIDE SENSE SENSOR + MAGNETS	\$49.99
291136	MY14 RIDESENSE ANT+	\$7.99
410000054	EXTENSION MOUNT NEOS/CONTINUUM SYNC	\$12.99
410000053	NEOS/CONTINUUM SYNC MOUNT	\$9.99



# PUMPS & ACCESSORIES



## CONTROL TOWER PRO

- High pressure floor pump with top mount gauge rated to 160PSI
- Chrome plated steel barrel with die cast base
- Grip tape base increases stability
- Auto head switches seamlessly between SV and PV, with pressure-release valve

Item	Colour	Price
640000010	SILVER	\$99.99

## CONTROL TOWER 1+

- 2.5" top mounted gauge
- Durable steel barrel and base
- Ergonomic handle adds comfort while storing ball inflation accessories
- Auto valve head with pressure release button
- 160psi

Item	Colour	Price
610000060	BLACK	\$74.99



## CONTROL TOWER 1

- High pressure floor pump with precision gauge
- Durable powder coat finish
- Auto Head automatically switches from between valve types
- Grip tape base increases stability

Item	Colour	Price
610000014	BLACK	\$54.99



## CONTROL TOWER 2

- Durable brushed Aluminum barrel finish
- Dual valve head, requires no valve head adjustment
- Grip tape base increases stability

Item	Colour	Price
610000021	CHARCOAL	\$44.99



## CONTROL TOWER 3

- Bomb-proof composite barrel and base
- Convertible head for SV/PV
- Ball needle included in base

Item	Colour	Price
610000025	BLACK	\$29.99



## CONTROL MINI PRO CO2

- Micro-sized pump and integrated CO2 inflator lets you choose between pumping or inflating with CO2
- Aluminum barrel
- Presta/ Schrader compatible
- 120psi

Item	Price
610000057	\$39.99



## CONTROL MINI PRO

- All aluminum body easily fits in your jersey pocket (130mm)
- Reversible valve head works for Presta and Schrader valve
- Aluminum barrel
- 120psi

Item	Price
610000058	\$34.99

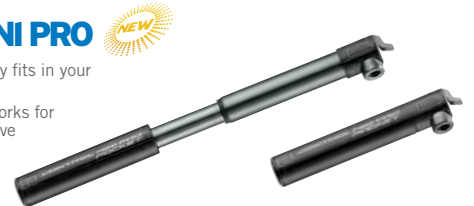

## CONTROL MINI ROAD+

- Lightweight and compact aluminum design
- 18.5mm wide air chamber, delivering Hi-Pressure
- Expandable internal hose with threadable valve for easy pumping

Item	PSI	Price
610000000	160	\$34.99



## CONTROL MINI MTB+

- Lightweight and compact aluminum design
- 20.5mm wide air chamber, delivering Hi-Pressure
- Expandable internal hose with threadable valve for easy pumping

Item	PSI	Price
610000003	140	\$34.99



## CONTROL MINI ROAD

- Full aluminum body
- Lightweight design
- Extendable T-Handle with Locking position

Item	PSI	Price
610000004	120	\$24.99



## CONTROL MINI MTB

- Full aluminum body
- Telescoping technology delivers Max-Volume
- Extendable T-Handle with Locking position

Item	PSI	Price
610000007	90	\$24.99



## CONTROL BLAST CO<sup>2</sup> KIT

- Design keeps thumb safe from cold air
- Simple push-on feature activates air cartridge
- Includes 1, 16g threaded CO<sup>2</sup> cartridge

Item	Price
610000009	\$18.99



## CONTROL BLAST CO<sup>2</sup> PACKS

- Thin foam insulation for best grip and comfort

Item	Size	Qty	Price
610000043	16g	3 PACK	\$9.99
610000044	16g	10 PACK	\$29.99
610000053	16G	50 PACK	\$139.99
610000054	25G	2 PACK	\$14.99
610000055	25G	6 PACK	\$34.99
610000056	25G	50 PACK	\$279.99



## CONTROL SHOCK PUMP

- Double function—inflates shocks and tires with included Presta adapter
- 300 PSI (20 bar) removable gauge for easy storage on or off the bike
- Foldable hose and T-handle
- 2-3 PSI micro-adjust bleeder button
- Rubber armored gauge prevents damage and increases accuracy and longevity

Item	Type	PSI	Colour	Price
690904	SHOCK PUMP	300	SILVER/BLACK	\$39.99

## REPLACEMENT PRESSURE GAUGE



Item	Replacement Part For	Price
610000036	CONTROL TOWER PRO	\$14.99
610000034	CONTROL TOWER 1	\$12.99



## REPLACEMENT AUTO HEAD AND HOSE

Item	Replacement Part For	Price
610000038	MY13 CONTROL TOWER PRO	\$23.99
610000032	MY13 CONTROL TOWER 1	\$19.99

## CONTROL TOWER PRO/1 O-RING



Item	Price
610000033	\$1.99

# BAGS



## WATERPROOF PANNIER

- Lightweight, high volume pannier bag for serious bike touring
- Perfex™ hi-frequency welded seams, TPU laminated fabrics and 100% waterproof
- Tool free Ego-Clutch™ rack mounting system
- Convenient and accessible side pocket
- Detachable shoulder strap
- Volume: 25L

Item  
430000016

\$89<sup>99</sup> /each



## CITY PANNIER

- Simple pannier bags for everyday shopping or commuting
- Water resistant laminated fabric
- Convenient tool-free installation
- Reflective safety accents
- Taillight hangers
- Volume: 20L

Item  
430000035

\$49<sup>99</sup> /set



## WATERPROOF BACKPACK

- Lightweight, high volume backpack ideal for messengers or commuters
- Perfex™ hi-frequency welded seams, TPU laminated fabrics and 100% waterproof
- Air-channel design helps to keep rider cool and dry
- Reflective safety marks and taillight hangers
- Convenient and accessible side pocket
- Detachable shoulder strap
- Volume: 25L

Item  
430000011

\$99<sup>99</sup>



## WATERPROOF HANDLEBAR BAG

- Hard shell waterproof handlebar bag
- Detachable map holder
- Adjustable foam compartments for photo equipment
- Perfex™ hi-frequency welded seams, TPU laminated nylon fabric and 100% waterproof
- Tool free Vertex® mounting system
- Detachable shoulder strap
- Volume: 3 Liters

Item  
430000015

\$89<sup>99</sup>



## HANDLEBAR BAG MINI

- Mini handlebar bag for frequently used gadgets
- Vertex® quick-release system
- Water resistant laminated fabrics
- Built-in rain cover
- Detachable shoulder strap
- Reflective safety accents

Item  
430000031

\$69<sup>99</sup>



## TRUNK BAG WP NEW

- ProTextura Plus™ waterproof trunk bag
- Ultrasonic welded seams, 840D
- TPU laminated nylon
- Reflective logos
- Tail light hangers

Item  
430000037

\$89<sup>99</sup>



## TRUNK BAG DX



- High-volume trunk bag with expandable pannier style side pockets.
- Adjustable foam compartments for photo equipment
- Water resistant laminated ProTextura™ fabrics
- Built-in rain cover
- Tool-free installation
- Detachable shoulder strap
- 3M Scotchlite™ reflective safety accents



Item 430000034 **\$99<sup>99</sup>**

## TRUNK BAG ST

- Standard trunk bag for touring
- Adjustable foam compartments for photo equipment
- Water resistant laminated fabrics
- Built-in rain cover
- Tool-free installation
- Detachable shoulder strap
- Reflective safety accents



Item 430000033 **\$79<sup>99</sup>**

## TRUNK BAG MINI

- Mini trunk bag for short trips
- Adjustable foam compartments for photo equipment
- Water resistant laminated fabrics
- Built-in rain cover
- Tool-free installation
- Detachable shoulder strap
- Reflective safety accents



Item 430000032

**\$49<sup>99</sup>**

## WATERPROOF SEAT BAG

- Lightweight yet high volume seat bag
- Perfex™ hi-frequency welded seams, TPU laminated fabrics and 100% waterproof.
- Easy to operate quick-release buckle system
- Taillight hanger
- Volume: 0.6L (S), 1.0L (M), 1.5L (L)



Item	Size	Price
430000014	L	\$34.99
430000013	M	\$29.99
430000012	S	\$24.99

## SEAT BAG DX



- Streamline, aero-shaped seat bag
- External side pockets
- Water resistant laminated fabrics
- Reliable Velcro™ strap fixer with tool-free installation
- Built-in key holder
- Reflective safety accents
- Taillight hanger
- Expandable zippered bottom (size L)



Item	Size	Price
430000029	L	\$29.99
430000028	M	\$24.99
430000027	S	\$19.99

## TOP TUBE BAG WP



- Quickly and easily access a camera or mobile phone on the road
- Perfex™ hi-frequency welded seams, TPU laminated fabrics, 100% waterproof
- Wide compatibility fits most bike frames
- Tool free installation
- Weight: 85g(S)/110g(L)
- Volume: 0.4L(S) /0.75L (L)''



Item	Size	Price
430000009	S	\$24.99
430000010	L	\$29.99



## QUICK FIX COMPRESS

Everything you need for a quick fix:

- 3 tire levers
- 9-function multi-tool

- CO<sup>2</sup> inflator, with 2 CO<sup>2</sup> 16g cartridges
- Seat bag

Item 610000050 **\$54<sup>99</sup>**



## QUICK FIX COMBO

Everything you need for a quick fix:

- 12 glueless patches
- 3 tire levers

- 9-function multi-tool
- Mini pump
- Seat bag

Item 610000049 **\$44<sup>99</sup>**



## SHADOW REPAIR WALLET

- Small weather resistant construction allows riders to carry ID, cash, and flat repair kit in a jersey pocket
- Includes Control Blast Inflator, 1 16g CO<sup>2</sup> cartridge, and Control Patch Kit with tire levers

Item 130826 **\$29<sup>99</sup>**



# WATER BOTTLE CAGES



## AIRWAY PRO1 CARBON

- Light weight 3K carbon fiber
- 25g

Item	Colour
490000057	MATT BLACK/WHITE
490000058	MATT BLACK/RED
490000059	MATT BLACK/GRAY



\$59<sup>99</sup>



## AIRWAY CARBON SIDEPULL

- Light weight 3K carbon fiber
- 45-degree removal/insertion (right hand)
- Suitable for smaller frames

Item	Colour	Hand
490000015	MATT BLACK/GRAY	RIGHT
490000016	MATT BLACK/WHITE	RIGHT
490000017	MATT BLACK/GRAY	LEFT
490000018	MATT BLACK/WHITE	LEFT



\$59<sup>99</sup>



## PROWAY CAGE

- High flex plastic material
  - Open construction
- is suitable for a wide variety of bottles

Item	Colour
490000037	BLACK/RED
490000038	BLACK/BLUE
490000039	BLACK/WHITE
490000040	BLACK/GRAY
490000041	WHITE/RED
490000042	WHITE/BLUE
490000043	WHITE/GREEN
490000044	WHITE/GRAY



\$19<sup>99</sup>



## PROWAY SIDEPULL

- High flex plastic material
  - 45-degree removal/insertion
- (right hand)
- Suitable for smaller frames

Item	Colour
490000045	BLACK/RED
490000046	BLACK/BLUE
490000047	BLACK/WHITE
490000051	WHITE/RED
490000052	WHITE/BLUE
490000053	WHITE/GRAY



\$19<sup>99</sup>



## AIRWAY AERO

- Low profile, aerodynamic water bottle shape
- Carbon constructed, integrated water bottle cage

Item  
490000019



\$79<sup>99</sup>

## GATEWAY ALLOY

- Tough, but still flexible alloy cages
- 47g

Item	Size	Colour
490000020	6mm	BLACK
490000021	6mm	SILVER
490000022	6mm	WHITE
490000023	6mm	BLUE
490000024	6mm	RED



\$5<sup>99</sup>

## GATEWAY ALLOY

- Tough, but still flexible alloy cages
- 32g

Item	Size	Colour
490000030	4mm	BLACK
490000031	4mm	SILVER
490000033	4mm	BLUE
490000034	4mm	RED



\$6<sup>99</sup>

## GATEWAY ALLOY SIDEPULL

- Tough alloy construction
- 45-degree removal/insertion (right hand)
- Suitable for smaller frames

Item	Colour
490000035	BLACK
490000036	SILVER



\$12<sup>99</sup>

## TRINITY BOTTLE CAGE ADAPTER

- Used to mount behind the seat for lower wind resistance
- Adjustable angle (1 or 2 bottles)
- Cages not included

Item  
970845



\$19<sup>99</sup>

# WATER BOTTLES



## GIANT SHIMANO NEW

Item	Size
48000006	600ml

**\$8<sup>99</sup>**



## POUR FAST AUTOSPRING



- Patented, leak proof valve, made by silica gel, no need to close
- Improved material thickness for easier squeeze
- 100% BPA-Free



Item	Size	Colour	Price
48000006	600ml	BLACK/BLUE	\$8.99
48000008	600ml	CLEAR/BLUE	\$8.99
48000010	600ml	BLACK/GRAY	\$8.99
48000012	600ml	CLEAR/GRAY	\$8.99
48000007	750ml	BLACK/BLUE	\$9.99
48000009	750ml	CLEAR/BLUE	\$9.99
48000011	750ml	BLACK/GRAY	\$9.99
48000013	750ml	CLEAR/GRAY	\$9.99



## POUR FAST EVERCOOL

- Patented, leak proof valve, made by silica gel, no need to close
- Insulated to keep temperature longer
- 100% BPA-Free

Item	Size	Colour
480000030	600ml	CLEAR/BLUE
480000031	600ml	CLEAR/BLACK
480000032	600ml	CLEAR/GRAY

**\$14<sup>99</sup>**



## POUR FAST DUST CAP

- Dust Cap for Pour Fast water bottles
- Keeps dust and contaminants away from opening

Item
480000034

**\$0<sup>99</sup>**

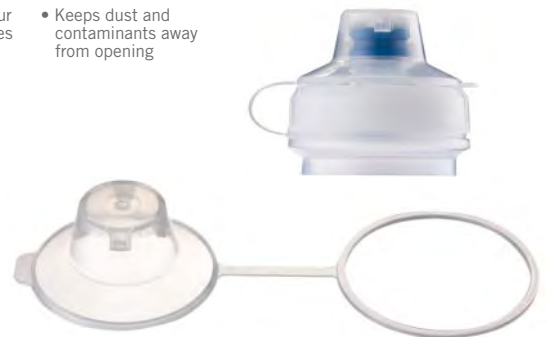

## GO-FLO



Water—even this basic necessity of hydration can be improved with a high-quality bottle. Giant's Go-Flo Water Bottles are BPA and phthalate free, and they look and feel great.

- Polypropylene (PP) bottle is BPA and phthalate free
- 100% recyclable

Item	Size	Colour	Price
971112	21oz	BLACK/ WHITE CUBE	\$3.99
971114	21oz	BLUE/ WHITE "G"	\$3.99
971115	21oz	WHITE/ BLUE "G"	\$3.99
971116	21oz	CLEAR/ BLUE "G"	\$3.99
971117	26oz	BLACK/ WHITE CUBE	\$4.99
971119	26oz	BLUE/ WHITE "G"	\$4.99
971120	26oz	WHITE/ BLUE "G"	\$4.99
971121	26oz	CLEAR/ BLUE "G"	\$4.99



# FENDERS



## ARC SERIES

- Super lightweight Polycarbonate material
- Easy installation mounts with front or rear quick release
- V-shape drainer design helps remove mud & water efficiently
- Single-arm stay mount for a clean, stylish outlook
- Kit includes one fender only

Item	Type	Size	Price
530000001	PRO	ROAD	\$59.99
530000002	SPORT	LIFESTYLE	\$64.99
530000005	SUSPENSION ADAPTER		\$19.99



## SPEEDSHIELD CLIP-ON



- Universal mudguard fits most down tubes
- Lightweight polypropylene material
- Easy tool-free installation
- Universal mount mudguard fits seat posts up to 32.5mm

Item	Type	Price
530000008	FRONT	\$14.99
530000009	REAR	\$14.99



## RAPID SERIES

- Designed specifically to fit Rapid and Dash series aluminum bikes
- Foul-weather-friendly, impact-resistant polycarbonate plastic construction
- Durable and lightweight stainless steel brake bridges, stays and hardware
- Adjustable attachment – 15mm vertical & horizontal

Item	Type	Tire Fit	Price
350901	ROAD SET	700x25	\$44.99



## SPEEDSHIELD 700C TOUR ALLOY

- Unbreakable all-weather alloy construction
- Quick adjusting stainless steel hardware
- Compatible with 700x35-45 city and trekking tires

Item	Type	Tire Fit	Price
351205	TREKKING SET	700x35-45	\$59.99



## SPEEDSHIELD 700C RACE

- Unbreakable all-weather polycarbonate construction
- Quick adjusting stainless steel hardware
- Compatible with 700x20-25 road tires

Item	Type	Tire Fit	Price
351204	ROAD SET	700x20-25	\$39.99



## SPEEDSHIELD 700C TOUR

- Unbreakable all-weather polycarbonate construction
- Quick adjusting stainless steel hardware
- Compatible with 700x35-45 city and trekking tires

Item	Type	Tire Fit	Price
351203	TREKKING SET	700x35-45	\$39.99



## SPEEDSHIELD 700C RACE CLIP-ON

- Durable, all-weather polypropylene construction
- Smart-Fix quick release attachment system
- Compatible with 700x20-25 road tires

Item	Type	Tire Fit	Price
351201	ROAD SET	700x20-25	\$19.99



## SPEEDSHIELD 700C TOUR CLIP-ON

- Durable, all-weather polypropylene construction
- Smart-Fix quick release attachment system
- Compatible with 700x35-45 city and trekking tires

Item	Type	Tire Fit	Price
351200	TREKKING SET	700x35-45	\$19.99



## SPEEDSHIELD 26"

- Unbreakable all-weather polycarbonate construction
- Quick adjusting stainless steel hardware
- Compatible with 26" MTB tires

Item	Type	Tire Fit	Price
351202	MTB SET	26"	\$39.99

# BELLS



## CLASSIC BELL

- UFO style
- Classic giant logo

Item	Colour
580901	BLACK
580902	BLACK/PINK
580903	PINK



\$6<sup>99</sup> 

## SPORT BELLS

- Adjustable quick release strap
- Ideal for MTB handlebars
- Fits 20-32mm handlebars

Item	Clamp	Colour
581000	20.0-32.0mm	MATTE BLACK
581001	20.0-32.0mm	MATTE GREY
581002	20.0-32.0mm	BLUE
581003	20.0-32.0mm	RED



\$8<sup>99</sup> 

## CRUISER BELLS

- 65mm dome
- Available in four fun colours
- Fits 21-26mm handlebars

Item	Clamp	Colour
581004	21.0-26.0mm	PLAID BLACK
581005	21.0-26.0mm	PLAID BLUE
581006	21.0-26.0mm	PLAID PURPLE
581007	21.0-26.0mm	PLAID RED/WHITE/BLUE



\$8<sup>99</sup> 

# RIM TAPE

## GIANT RIM TAPE

- Strong nylon reinforced PVC for a secure fit
- Handles high-pressures; does not rot
- 0.5mm thick



Item	Type	Width	Qty	Price
320000000	700c Road	16mm	Box of 2	\$7.99
320000001	700c Touring	18mm	Box of 2	\$7.99
320000009	27.5	24mm	Box of 2	\$7.99
870908	26"	18mm	Box of 2	\$4.99
870909	26"	18mm	10m	\$9.99
870927	700c	16mm	10m	\$9.99



# TUBES

\*Please place orders in QTY's of 10, 50 or 100

## SCHRAEDER\*

Item	Size
330000000	12 1/2x1.75-2 1/4 35mm
330000003	16x1.75-2.125 35mm
330000009	20x1.75-2.1 35mm
330000015	24x1.9-2.1 35mm
330000020	26x1.5-1.75 35mm
330000023	26x1.9-2.35 35mm
330000029	26x1.9-2.35 48mm
330000037	26x2.35-2.6 HD 35mm 1.2mm
330000033	26x1.9-2.35 35mm Thorn Resistant
330000035	26x2.35-2.6 DH 35mm 2.25mm
330000038	29x1.9-2.3 35mm
330000048	700x20-25 35mm
330000056	700x28-32 35mm
330000063	700x35-45 35mm

## PRESTA\*

Item	Size
330000022	26x1.5-1.75 32mm Threaded
330000026	26x1.9-2.35 32mm Threaded
330000030	26x1.9-2.35 32mm Threaded Thorn Resistant
330000034	26x2.35-2.6 DH 48mm Threaded 2.25mm
330000071	27.5x2.1-2.4 48mm
330000039	29x1.9-2.3 48mm Threaded
330000041	650x20-23 48mm Threaded
330000052	700x20-25 32mm Threaded
330000054	700x28-32 32mm Threaded
330000049	700x20-25 48mm Threaded
330000060	700x28-32 48mm Threaded
330000062	700x35-45 32mm
330000042	700x20-25 48mm Smooth Ultra Light 0.6mm
330000046	700x20-25 60mm Smooth Ultra Light
330000072	700x28-32 60mm
330000045	700x20-25 60mm
330000051	700x20-25 80mm Smooth Ultra Light

## BULK \*\*Boxes of 50

### SCHRAEDER\*\*

Item	Size
330000010	20x1.75-2.1 35mm
330000024	26x1.9-2.35 35mm
330000057	700x28-32 35mm
330000064	700x35-45 35mm



### PRESTA\*\*

Item	Size
330000027	26x1.9-2.35 32mm Threaded
330000050	700x20-25 48mm Threaded



# RACKS



## RACK-IT TOUR

- Light weight construction
- 25kg capacity
- Easy assembly
- International rear light interface
- Klickfix system compatible

Item	Colour	Price
711200	BLACK	\$39.99



## RACK-IT BEAM SEATPOST RACK

- Tubular aluminum construction
- Quick adjust sliding cargo tray
- Quick release attachment compatible with 25.4mm-31.6mm seat post

Item	Capacity	Colour	Price
710932	22 lbs	BLACK	\$39.99
710934	22 lbs	SILVER	\$39.99



## RACK STRAP

- Black elastic straps for rear racks
- Sold individually

Item	Colour	Length	Price
710618	BLACK	26"	\$5.99



## QR SEAT COLLAR W/ RACK MOUNTS

- Integrated rack mount holes
- Aluminum construction
- Ideal for use on Giant Alloy Rack

Item	Type	Size	Price
710603	CLAMP	31.8mm	\$9.99
710605	CLAMP	34.9mm	\$9.99
710614	DISC RACK ADAPTER LONG		\$5.98

# KICKSTANDS



## ALLOY ADJUSTABLE

- Alloy kickstand w/ 2-point mounting system
- Adjustable to fit a wide range of bikes
- Allows easy removal of rear wheel

Item	Colour	Price
550434	BLACK	\$19.99



## ALLOY CENTER-MOUNT

- Alloy kickstand w/ single bolt system
- Allows easy removal of rear wheel

Item	Colour	Price
550801	BLACK	\$9.99



## SEEK / ROAM XR

- Alloy kickstand w/ 2-point mounting system
- Adjustable within 24" - 28"
- Mounts to rear dropout

Item	Type	Colour	Price
550970	REAR MOUNT	BLACK	\$18.99

# ACCESSORIES



## TRAINING WHEELS

Item	Size	Price
910522	16"- 20"	\$15.99



## STANDARD LOGO BIKE STAND/29ER STAND

- Rubberized foot pads and prongs to protect floors and your bikes' paint
- Fits any bike with or without disc brakes
- Please order in multiples of 5

Item	Colour	Size	Price
839602	SILVER	24" - 700C	\$34.99
261004	SILVER	29"	\$34.99



## FOLDABLE BIKE COVER

- Bag is attached to the cover for easy use
- Made from 100% Polyurethane-coated nylon
- Fits most bicycles

Item	Colour	Price
580500	SILVER/BLUE	\$39.99

# WHEEL ACCESSORIES



## VALVE EXTENSIONS

Item	Size	Price
330000066	50mm	\$5.99
330000067	40mm TUBELESS	\$5.99
330000068	TUBELESS VALVE (PAIR)	\$9.99

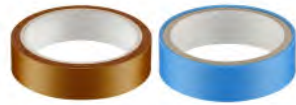

## TUBELESS KITS FOR WHEELSYSTEMS

- Includes self-adhesive rim tape (pair)
- Includes tubeless valves
- Off road kit to be used with disc brake only

Item	Size	Rim Width	Price
320000006	ON ROAD WIDE	20-24mm	\$14.99
320000007	ON ROAD NARROW	16-20mm	\$14.99
320000008	OFFROAD	19-25mm	\$5.99

## CONVERSION KITS

Item	Size	Price
300000000	135MM TO 142MM	\$44.99
300000001	100/15MM TO 100/9MM	\$39.99

# CHAINS



## STANDARD CHAIN

- Economical replacement chain for single speed
- Comes w/ master link
- Perfect for coaster style bikes or BMX

Item	Size	Links	Price
270501	1/2" x 1/8"	112	\$9.99



## HP 7/8 CHAIN

- Compatible w/ 7 & 8 speed systems
- Durable hardened pins and heat treated chamfered side plates
- Master link included

Item	Size	Links	Price
270203	1/2" x 3/32"	116	\$14.99



## PRO 7/8 CHAIN

- Compatible w/ 7 or 8 speed systems
- Durable hardened pins and heat treated chamfered side plates
- Bulls eye riveted for added strength
- Master link included

Item	Size	Links	Price
270603	1/2" x 3/32"	116	\$19.99



## POSI-SHIFT 9SPD CHAIN HIGH PERFORMANCE

- 9 speed super narrow 6.6mm chain
- Durable hardened pins and heat treated chamfered side plates
- Stretch proof mushroomed pin
- Master link included

Item	Size	Links	Price
270204	1/2" x 3/32"	116	\$31.99

# BRAKE PADS



## 3C ROAD CALIPER & PADS

- Triple compound pads maximize braking power, reduce noise and shed dirt
- Great braking power in dry and wet condition
- Designed for alloy rims
- Ultra-light 6061 T6 forged holder design
- Compatible with Shimano, SRAM, TRP

Item	Price
290000001 3C Road Caliper	\$19.99
290000002 3C Road Pads	\$5.99



## CARTRIDGE ROAD PADS

- High friction compound for improved stopping
- Alloy carrier w/ pad retention bolt
- Set includes mounting hardware

Item	Price
213025	\$18.99/PAIR



## CARTRIDGE REPLACEMENT PADS (INSERT)

- Compatible w/ most existing cartridge pads
- High friction compound for improved stopping
- Slotted braking surface for water dissipation

Item	Price
213026	\$4.99/PAIR



## 3C V-BRAKE CALIPER & PADS

- Triple compound and tread pattern for maximizes braking power, reduces noise and sheds dirt
- Great braking power in dry and wet conditions
- Ultra-light 6061 T6 forged holder design
- Compatible with Shimano, SRAM, TRP

Item	Price
290000005 3C V-brake Caliper	\$19.99
290000006 3C V-brake pads	\$5.99



## PERFORMANCE V-BRAKE PAD

- High friction compound for improved stopping
- Set includes mounting hardware
- Compatible w/ all existing V-brake designs

Item	Price
213022	\$12.99/PAIR

# CABLES & HOUSING



## GALVANIZED SLICK CABLE

- Smooth surface and low friction design
- Pre-stretched for precision braking, cuts down on break-in time

Item	Type	Size	Quantity	Price
210901	MTB BRAKE	1.5x1700mm	100	\$99.99
210921	ROAD BRAKE	1.1x2000mm	100	\$174.99
210903	SHIFT			\$6.99



## STAINLESS STEEL SLICK CABLE

- Smooth surface and low friction design
- Pre-stretched for precision braking, cuts down on break-in time
- Permanent rust free performance

Item	Type	Size	Quantity	Price
210902	MTB BRAKE	1.5x1700mm	100	\$174.99
210904	SHIFT			\$159.99



## TEFLON STAINLESS STEEL CABLE

- Teflon coated cable, friction free, corrosion resistance
- Pre-stretched for precision braking, cuts down on break in time
- Permanent rust free performance
- Double-ended for use w/ road or mountain

Item	Type	Price
210221	BRAKE	\$8.99
210220	SHIFT	\$8.99



## ULTRASLICK SHIFT CABLE KIT

- High performance cable upgrade kit for precision shifting
- Lubricated L3 liner reduces friction and increases modulation
- Includes 1.8 meters of housing, 2 Teflon coated stainless cables, a sealing liner, alloy ferrules and end caps
- Compatible w/ all primary components systems



Item	Type	Price
210800	UNIVERSAL FOR MTB OR ROAD	\$39.99



## ULTRASLICK BRAKE CABLE KIT

- Kevlar reinforced compression-free housing for maximum braking performance
- 30% lighter than conventional brake housing
- Lubricated L3 liner reduces friction and increases performance
- Includes 3 meters of housing, 2 Teflon coated stainless cables, a sealing liner, alloy ferrules and end caps
- Compatible w/ all primary components system



Item	Type	Price
210801	MTB	\$34.99
210802	ROAD	\$34.99



## ALLOY CABLE ENDS

- The finishing touch to any cut cable

Item	Type	Quantity	Price
210944	BRAKE	500	\$16.99
210943	SHIFT	500	\$16.99



## HOUSING FERULES

- Fits all cable housing

Item	Type	Quantity	Size	Price
210940	BRAKE	200	5mm	\$16.99
210701	SHIFT	200	4mm	\$16.99



## BRAKE CABLE HOUSING

- Brake Cable Housing
- Low friction polymer liner
- Super durable plastic layer
- Compatible w/ SLR, M system brake housing

Item	Size	Colour	Price
210918	5mm x 50m	Black	\$41.99

## SHIFT CABLE HOUSING

- Low friction polymer liner aids in shifting performance
- Compressionless housing

Item	Size	Colour	Price
210916	4mm x 50m	Black	\$99.99

# LUBRICANT



## AGENT ORANGE™ CITRUS DEGREASER

- Powerful citrus based degreaser and cleaner
- Fast foaming action peels away grime
- Biodegradable and non-toxic

Item	Size	Applicator	Price
610607	14oz	AEROSOL	\$11.99



## DRY SILK™ TEFLON+ LUBE

- High performance DuPont Teflon based spray lube
- Holds up to extreme pressures and resists water wash-off
- Works on derailleurs, cliplless pedals and more

Item	Size	Applicator	Price
610601	10.5oz	AEROSOL	\$13.99



## LIQUID SILK™ LUBE

- Petroleum based light spray lube
- Foaming chain lube for longest and strongest protection
- Durable wet weather performance, muddy off-road condition and long rainy commutes

Item	Size	Applicator	Price
610602	11oz	AEROSOL	\$9.99



## LIQUID SILK™ SILICON LUBE

- Specially formulated for use on indoor cycling equipment
- Won't attract dust & dirt
- Use on cables, pulleys, slides, plastic or rubber parts
- Works on treadmills too

Item	Size	Applicator	Price
610604	11oz	AEROSOL	\$13.99



## FRESH SPEED™ CITRUS CHAIN WAX

- Citrus-paraffin formula dries to a dirt and friction busting film
- Great performance in wet and dry weather conditions
- Works on cables, spoke nipples and derailleurs

Item	Size	Applicator	Price
610603	11oz	AEROSOL	\$11.99



# TOOLS



## TOOL SHED HD1 MULTI-TOOL

With the right tool you can take care of any situation. Giant's all-new Tool Shed HD1 multi-tool is your solution; your trusted companion no matter where the path leads.

- 17 function folding multi-tool
- Fixed 180° open position
- 2, 2.5, 3, 4, 5, 6, 8mm hex wrenches; #2 Phillips & flat screwdrivers; T25 & T30 Torx wrenches, chain tool, tire lever, three standard spoke wrenches, T30 Mavic spoke wrench

Item	Price
951102	\$39.99



## TOOL SHED HD2 MULTI-TOOL

- 8 function folding multi-tool
- Fixed 180° open position
- 2, 2.5, 3, 4, 5, 6, 8mm hex wrenches; #2 Phillips & flat screwdrivers

Item	Price
951103	\$22.99



## LOGO'D FOLDING TOOL

- Includes 2, 4, 5, 6mm Hex keys along with Phillips and flat head screwdrivers

Item	Price
950836	\$14.99



## TOOLSHED CHAIN TOOL

- Fit 8-11 speed
- One piece die-casting
- Double-sided replacement pins
- Integrated bottle cap opener

Item	Price
60000000	\$29.99



### CHAIN TOOL

- Chrome plated chain tool
- Compatible w/ HG, IG and UG chains
- Extra long knurled handle for good leverage
- Adjustable backing support braces the back plate of the chain
- Replaceable driver pin

Item	Price
950831	\$12.99



### CARBON SEATPOST REPAIR-STAND CLAMP ADAPTER

- Protects composite frames & seatpost from repair stand clamps
- Fits all Giant designs including TCR ISP, Vector, Aero, 27.2mm and 30.9mm
- Tool-free use

Item	Price
950839	\$35.99



### TORQKEY

- Designed to offer convenient precision torque settings for high end components
- Available in 4Nm and includes 3, 4, and 5mm interchangeable hex bits

Item	Size	Price
950844	4Nm 3, 4, 5mm hex bits	\$15.99
950845	6mm	\$15.99



### Y-SOCKET WRENCH

- Made of hardened tool steel
- Durable chrome finish
- Incorporates 8, 9 and 10mm sizes
- Comfortable molded rubber handle

Item	Size	Price
950804	8, 9, 10mm	\$9.99



### Y-ALLEN WRENCH

- Made of hardened tool steel
- Durable chrome finish
- Incorporates 4, 5 and 6mm Allen head sizes
- Comfortable molded rubber handle

Item	Size	Price
950827	4, 5, 6mm	\$9.99



### O TYPE SPOKE WRENCH

- Hardened tool steel
- Chrome plated
- Fits 10, 11, 12, 13, 14, and 15 spoke nipples
- Knurled outside edge provides sure grip

Item	Price
950829	\$7.99



### TIRE LEVERS

- Compact, durable nylon construction
- Set clips together for convenient storage

Item	Quantity	Price
950828	Set of 3	\$7.99

The Liv logo is a stylized, purple, italicized font. It features a thick, rounded 'L' followed by a 'i' with a dot and a 'v' with a thick, rounded bottom. The letters are slanted to the right.

## GEAR

*Liv gear is tailored to meet a woman's needs. From beautiful apparel to women's specific saddles, Liv gear helps you make the most of your riding experience.*



ELEVATE  
YOUR RIDE.



*RIDER GEAR*

Gear for me.



*BIKE GEAR*

Gear for my bike.



# HELMET TECHNOLOGY

FROM COMPETITION TO COMMUTING, ON-ROAD OR OFF-ROAD, YOUR HELMET IS YOUR MOST IMPORTANT ACCESSORY.

Liv's new lineup of helmets, including the high-performance Rev road helmet, features the cutting-edge technologies below to keep you cool, comfortable and secure on your rides.



**Liv**  
**REV**

## PERFORMANCE, COMFORT, AND GREAT LOOKS.

The new Rev helmet from Liv gives women riders superior technologies and lightweight design, all in a style you can call your own. With several colors to choose from, it's your most vital gear choice for quick spins or all-day road rides.

## FEATURES

### 1 INTERNAL STRUCTURAL SHELL

A continuous internal polycarbonate shell fuses the helmet structure together. The result is increased overall strength and toughness, and reduced overall weight.

### 2 IN-MOLD MICROSHELL/EPS CONSTRUCTION

The most advanced construction process is used to ensure consistent, seamless materials throughout the helmet for optimal protection and a flawless look. The In-mold microshell provides all-in-one construction for maximum structural integrity.

### 3 TRANSTEXTURA™ PLUS PADDING

These highly advanced natural fabrics fight bacteria growth by pulling sweat from the rider's head and transferring it through exhaust ports in the 21-vent design. The natural property of the fabric inhibits microbes that cause odors.

### 4 CINCH+™ FIT SYSTEM

The perfect blend of safety and comfort. Cinch+ offers optimal coverage by cradling the occipital bone for full protection, support and comfort. Large scoop-like paddles protrude outward to cradle the cranium.

### 5 LITEFORM™ STRAP WEBBING

Using a special blend of thin, lightweight and tough woven material creates uncompromising strength and toughness, and reduced overall weight.

# FABRIC TECHNOLOGY

---

Comfort and moisture management are the primary goals of any performance sport fabric. In cooler conditions, wet heat conduction robs the body of heat, leaving the wearer uncomfortable. Conversely, on a hot day the same moisture is a barrier to heat release, which can lead to overheating. The fabric technologies in Liv apparel are designed to regulate temperature and keep you comfortable in all types of conditions.

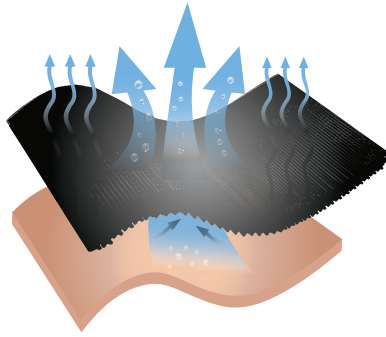

**TransTextura™**

## **TransTextura™**

Designed with denier gradient transfer technology, which uses larger diameter fibers next to the skin to pull moisture to the outer surface for evaporation and quick drying.



**ProTextura™**

## **ProTextura™**

Wind protection and durable water-repellent finishes and laminations are engineered to overcome wind, wet and rainy conditions. Features breathability to help your body regulate temperature.

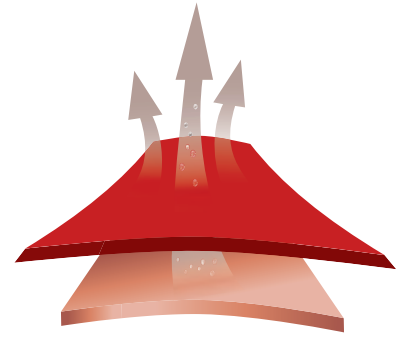

**ThermTextura™**

## **ThermTextura™**

Builds on TransTextura™ with fleece on the backside of the fabric to add insulating air and protect you from the elements.

# LIV APPAREL FIT SYSTEM

---

These options help you choose the best clothing for your riding style and fit preferences.



RACE FIT

## RACE FIT

This form-fitting cut is ideal for race conditions and professional level cycling. The tight fit reduces wind resistance, while the functional high-tech fabric is suitable for all-condition riding.



CLUB FIT

## CLUB FIT

This fit is not too loose or too tight, providing a comfortable and performance-minded apparel option. The female-specific cut is paired with breathable and flexible fabrics, helping you perform at your best.



RELAXED FIT

## RELAXED FIT

This fit collection combines looser fitting, stylish looks with comfortable, high-wicking fabrics that you can wear on and off the bike.

# CHAMOIS TECHNOLOGY

Liv women's-specific chamois technologies offer multiple levels of comfort and protection using high-density, multi-thickness foam for optimal weight distribution on the saddle and maximum comfort for all levels of riders. A breathable antibacterial top layer minimizes chafing, absorbs moisture, and fights odor and bacteria.

## ProComfor™

### RACE DAY series



Liv ProComfor™ women's specific chamois provides triple density protection and the TransTextura Plus™ fabric provides antimicrobial functionality. The all-way stretch fabric reduces chafing, and the high density foams concentrated in the major anatomical pressure points provide incredible comfort and a great fit for challenging rides.

### SIGNATURE series



Liv ProComfor™ chamois is proven and tested by pros. A special TransTextura Plus™ microfiber fabric guarantees adequate moisture control and hygiene. The width and length of the chamois is precisely measured and strategically positioned. Flat seams with a stretch thread allow the chamois to move with the movements of the body and prevent friction, overheating and chafing.

## SportComfor™

### FISSO & CADENCE series



Liv SportComfor™ chamois has been specifically designed for the female anatomy. It combines extreme lightness with high density protective foams located in the pressure points. Soft wings offer maximum comfort and freedom of movement.

## CoreComfor™

### MOSSA series



Liv CoreComfor™ chamois is a dual density women's specific chamois that was developed to provide freedom of movement, good protection, and superior comfort.

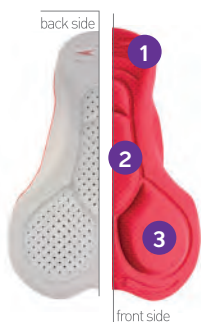

1. TransTextura Plus™ fabric—Bacteriostatic, great breathability, excellent sweat absorption
2. Specially designed perineal area without bulkiness
3. Triple density and three dimensional shape

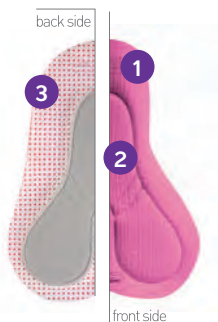

1. TransTextura Plus™ fabric—Bacteriostatic, great breathability, excellent sweat absorption
2. Wide central perineal area specially shaped for women's anatomy
3. Super air base layer for maximum ventilation



1. TransTextura Plus™ fabric—Bacteriostatic, great breathability, excellent sweat absorption
2. Specially designed perineal area without bulkiness
3. High density foam for ischiatic protection



1. TransTextura™ fabric
2. Specially designed perineal area without bulkiness
3. Multi-thickness foam shape

# LIV RIDER APPAREL



## LIV RACE DAY SS JERSEY NEW

- Liv RACE FIT
- TransTextura™ fabric wicks moisture and dries quickly
- High-visibility reflective accents
- Full height collar
- 3 rear pockets
- Elastic waist

Item	Size
850001216	XS
850001217	S
850001218	M
850001219	L
850001220	XL

Colour:  
WHITE/BLACK



**\$129<sup>99</sup>**



## LIV RACE DAY LS JERSEY NEW

- Liv RACE FIT
- ThermTextura™ fabric
- High-visibility reflective accents

Item	Size
850001226	XS
850001227	S
850001228	M
850001229	L
850001230	XL

Colour:  
WHITE/BLACK



**\$159<sup>99</sup>**



## LIV RACE DAY BIB SHORT NEW

- Liv RACE FIT
- ProComfor™ women's-specific chamois
- Sublimated silicon gripper hem
- Excellent structure recovering fabric

Item	Size
860000377	XS
860000378	S
860000379	M
860000380	L
860000381	XL

Colour:  
BLACK



**\$159<sup>99</sup>**



## LIV SIGNATURE SS JERSEY NEW

- Liv Race Fit
- Full length front zipper
- 3 rear pockets
- Non-restrictive collar
- Sublimated graphics
- TransTextura™ fabric wicks moisture and dries quickly
- High-visibility reflective accents

Item	Size
850001254	XS
850001255	S
850001256	M
850001257	L
850001258	XL

Colour:  
WHITE



**\$169<sup>99</sup>**



## LIV SIGNATURE SHORTS NEW

- Liv Race Fit
- Strategically-placed flatlock seams for comfort
- Sublimated graphics
- ProComfor™ women's specific chamois

Item	Size
860000409	XS
860000410	S
860000411	M
860000412	L
860000413	XL

Colour:  
BLACK/WHITE



**\$219<sup>99</sup>**



## LIV ROSA SS JERSEY

- Quick-drying, moisture-wicking TransTextura fabric
- Full-length reflective front zipper
- 3 back pockets
- Flatlock seams, non-restrictive collar
- Race fit

Item	Size
850000510	XS
850000511	S
850000512	M
850000513	L
850000514	XL

Colour:  
BLACK/WHITE



**\$99<sup>99</sup>**



## LIV ACCELERATE SS JERSEY NEW

- Liv CLUB FIT
- TransTextura™ moisture-wicking, quick-drying fabric
- Flatlock seams, non-restrictive collar

Item	Size
850001096	XS
850001097	S
850001098	M
850001099	L
850001100	XL

Colour:  
CORAL/CHARCOAL



**\$89<sup>99</sup>**



## LIV AQUA SS JERSEY NEW

- Liv CLUB FIT
- TransTextura™ moisture-wicking, quick-drying fabric
- Flatlock seams, non-restrictive collar

Item	Size
850001086	XS
850001087	S
850001088	M
850001089	L
850001090	XL

Colour:  
AQUA/BLUE



**\$89<sup>99</sup>**



## LIV FELIZ SS LONGTOP JERSEY NEW

- Liv Club Fit
- Front zipper
- 3 back pockets
- Long hem, which can be worn as dress
- Side ties can turn Feliz into stylish long jersey
- Flatlock seams
- Quick-drying, moisture-wicking
- TransTextura™ fabric

Item	Size
850001201	XS
850001202	S
850001203	M
850001204	L
850001205	XL

Colour:  
CHARCOAL/CORAL



**\$84<sup>99</sup>**



## LIV RADIANT LS JERSEY NEW

- Liv Relaxed Fit
- Full length front zipper
- 3 back pockets
- Non-restrictive collar
- Sublimated graphics
- ThermTextura™ fabric

Item	Size
850001196	XS
850001197	S
850001198	M
850001199	L
850001200	XL

Colour:  
BLACK/WHITE



**\$99<sup>99</sup>**



## LIV CADENCE SHORTS NEW

- Liv Race Fit
- Strategically-placed flatlock seams for comfort
- Colored waistband and cuffs
- Crossover waistband for increased comfort
- SportComfor™ women's specific chamois

Item	Size
860000362	XS
860000363	S
860000364	M
860000365	L
860000366	XL

Colour:  
BLACK/AQUA



**\$89<sup>99</sup>**



## LIV CADENCE KNICKERS NEW

- Liv Race Fit
- Strategically-placed flatlock seams for comfort
- Colored waistband and cuffs
- Crossover waistband for increased comfort
- SportComfor™ women's specific chamois

Item	Size
860000367	XS
860000368	S
860000369	M
860000370	L
860000371	XL

Colour:  
BLACK/PURPLE



**\$99<sup>99</sup>**



## LIV FISSO SHORT

- Quick-drying, moisture-wicking TransTextura Plus fabric
- SportComfor women's-specific chamois
- Strategically-placed flatlock seams for comfort
- Crossover waistband for increased comfort



Item	Size
860000279	XS
860000280	S
860000281	M
860000282	L
860000283	XL



**\$79<sup>99</sup>**

## LIV FISSO TIGHT

- TransTextura moisture-wicking, quick-drying fabric
- SportComfor women's-specific chamois
- Crossover waistband for increased comfort
- Flatlock seams



Item	Size
860000289	XS
860000290	S
860000291	M
860000292	L
860000293	XL



**\$99<sup>99</sup>**

## LIV FISSO KNICKER

- TransTextura moisture-wicking, quick-drying fabric
- SportComfor women's-specific chamois
- Crossover waistband for increased comfort
- Flatlock seams



Item	Size
860000284	XS
860000285	S
860000286	M
860000287	L
860000288	XL



**\$89<sup>99</sup>**

## LIV VENTO SS JERSEY



- Liv Club Fit
- 1/2-length zipper
- 3 back pockets
- Flatlock seams, non-restrictive collar
- Quick-drying, moisture-wicking TransTextura™ fabric



Item	Size
850000976	XS
850000977	S
850000978	M
850000979	L
850000980	XL

**Colour:**  
AQUA/BLUE



**\$69<sup>99</sup>**

## LIV FORMA SS



- Liv/giant CLUB FIT
- TransTextura™ fabric wicks moisture and dries quickly
- High-visibility reflective accents
- 1/2-length zipper
- Unrestrictive collar
- 3 pockets



Item	Size
850000789	XS
850000790	S
850000791	M
850000792	L
850000793	XL

**Colour:**  
CHARCOAL



**\$69<sup>99</sup>**

## LIV PASSION SS JERSEY



- Liv RELAXED FIT
- TransTextura™ moisture-wicking, quick-drying fabric
- Flatlock seams, non-restrictive collar



Item	Size
850001031	XS
850001032	S
850001033	M
850001034	L
850001035	XL

**Colour:**  
CHARCOAL/CORAL



**\$59<sup>99</sup>**

## LIV MOSSA SHORT

- TransTextura moisture-wicking, quick-drying fabric
- CoreComfor women's-specific chamois
- Self-fabric cuffs
- Flatlock seams

Item	Size	Colour
860000213	XS	BLACK/WHITE
860000214	S	BLACK/WHITE
860000215	M	BLACK/WHITE
860000216	L	BLACK/WHITE
860000217	XL	BLACK/WHITE
860000264	XS	BLACK
860000265	S	BLACK
860000266	M	BLACK
860000267	L	BLACK
860000268	XL	BLACK



**\$59<sup>99</sup>** 

## LIV CHARM SS JERSEY

- Liv RELAXED FIT
- TransTextura™ moisture-wicking, quick-drying fabric
- Stylish enough to wear on or off of the bike

Item	Size	Colour
850001136	XS	CHARCOAL/CORAL
850001137	S	CHARCOAL/CORAL
850001138	M	CHARCOAL/CORAL
850001139	L	CHARCOAL/CORAL
850001140	XL	CHARCOAL/CORAL
850001151	XS	BLACK/WHITE
850001152	S	BLACK/WHITE
850001153	M	BLACK/WHITE
850001154	L	BLACK/WHITE
850001155	XL	BLACK/WHITE



**\$89<sup>99</sup>**  

## LIV PASSO BAGGY SHORT

- Removable chamois liner short
- Ideal for off-road riding
- Durable stretch fabric, multiple pockets
- 12" inseam
- Belt loops and adjustable waist band

Item	Size	Colour
860000299	XS	GRAY
860000300	S	GRAY
860000301	M	GRAY
860000302	L	GRAY
860000303	XL	GRAY
860000309	XS	BLACK
860000310	S	BLACK
860000311	M	BLACK
860000312	L	BLACK
860000313	XL	BLACK



**\$99<sup>99</sup>**  

## LIV RACE DAY WINDBREAKER VEST

- Liv Race Fit
- Sublimated patterns
- Full-length front zipper
- High-visibility reflective accents
- Venting stretch mesh panels
- Lightweight
- Windproof ProTextura™ fabric

Item	Size
850001221	XS
850001222	S
850001223	M
850001224	L
850001225	XL

Colour:  
WHITE/BLACK



**\$109<sup>99</sup>**  

## LIV SIGNATURE RAIN JACKET

- Liv Race Fit
- ProTextura™ fabric has a high waterproof rating of 10,000mm, and equally breathable
- Venting stretch mesh panels
- Full-length front zipper
- Reflective highlights
- Unique sublimated patterns

Item	Size
850001264	XS
850001265	S
850001266	M
850001267	L
850001268	XL

Colour:  
BLACK/GRAY



**\$249<sup>99</sup>**

## LIV WINDBREAKER JACKET

- ProTextura windproof fabric
- Liv/giant Club fit
- Reflective accents
- Zip rear pocket access

Item	Size
850000714	XS
850000715	S
850000716	M
850000717	L
850000718	XL

Colour:  
AQUA



**\$99<sup>99</sup>**

## LIV TEAM TRACK JACKET

- TransTextura fabric™ for all day comfort
- UPF 30 sun protection
- Liv Corporate branding



Item	Size
880000230	S
880000231	M
880000232	L

Colour:  
BLACK



**\$74<sup>99</sup>**

## LIV TEAM DRESS SHIRT

- TransTextura fabric™ for all day comfort
- Liv Corporate branding
- UPF 30 sun protection



Item	Size
880000218	S
880000219	M
880000220	L

Colour:  
BLACK



**\$64<sup>99</sup>**

## LIV TEAM HOODIE

- TransTextura fabric™ for all day comfort
- Liv Corporate branding
- UPF 30 sun protection



Item	Size
880000224	S
880000225	M
880000226	L



Colour:  
MELANGE

**\$114<sup>99</sup>**

# LIV ACCESSORIES



## LIV BOLERO

- TransTextura Plus moisture-wicking, quick-drying fabric
- UPF 50 sun protection
- Mesh panels for venting



Item	Size	Colour
820000084	S	WHITE
820000085	M	WHITE
820000086	L	WHITE
820000087	S	BLACK
820000088	M	BLACK
820000089	L	BLACK



**\$29<sup>99</sup>**

## LIV BASELAYER

- Liv RACE FIT
- TransTextura Plus™ fabric quickly wicks moisture and eliminates odor causing bacteria
- Drop tail cycling specific construction



Item	Style	Colour	Price	Size
840000087	S/S	GRAY	\$44.99	XS
840000088	S/S	GRAY	\$44.99	S
840000089	S/S	GRAY	\$44.99	M
840000090	S/S	GRAY	\$44.99	L
840000107	S/L	GRAY	\$39.99	XS
840000108	S/L	GRAY	\$39.99	S
840000109	S/L	GRAY	\$39.99	M
840000110	S/L	GRAY	\$39.99	L



## LIV THERMAL ARM WARMER

- Liv RACE FIT
- Flatlock seams
- High-visibility reflective accents
- ThermTextura™ fabric"

Item	Size	Colour
820000281	S	BLACK
820000282	M	BLACK
820000283	L	BLACK

Colour:  
BLACK



**\$34<sup>99</sup>**  

## LIV MIDTHERMAL KNEE WARMER

- Liv RACE FIT
- Flatlock seams
- High-visibility reflective accents
- ThermTextura™ fabric"

Item	Size	Colour
820000284	S	BLACK
820000285	M	BLACK
820000286	L	BLACK

Colour:  
BLACK



**\$39<sup>99</sup>**  

## LIV TEAM CAP

- Classic 6-panel structure with vents
- Adjustable fit



Item	Size	Colour	Price
820000287	OSFM	WHITE	<b>\$19<sup>99</sup></b>

## LIV TRANSTEXTURA CYCLING CAP

- TransTextura™ sweatband absorbs excess moisture
- Lightweight mesh fabric fits easily under helmet



Item	Size	Colour	Price
820000292	OSFM	WHITE	<b>\$19<sup>99</sup></b>

## LIV RACE DAY SOCK

- Ultra-thin single-ply construction
- Excellent ventilation and moisture transfer properties
- Ultra high gauge 200-needle count
- Left & right anatomical structure

Item	Size	Colour	Price
820000358	XS/S	BLACK	<b>\$14<sup>99</sup></b>
820000359	M/L	BLACK	



## LIV SHORT 'N' SWEET SOCK

- TransTextura™ moisture transfer-technology
- Comfortable for cycling and everyday use
- Very thin and fine smooth touch

Item	Size	Colour	Price
820000344	XS/S	BLACK	<b>\$5<sup>99</sup></b>
820000345	M/L	BLACK	
820000346	XS/S	WHITE	
820000347	M/L	WHITE	



## LIV SWEET SOCK

- TransTextura™ moisture transfer technology
- Comfortable for cycling and everyday use
- Very thin and fine smooth touch

Item	Size	Colour
820000348	XS/S	BLACK
820000349	M/L	BLACK

**\$7<sup>99</sup>** 



## LIV LUX MERINO QUARTER SOCK

- Genuine Merino wool insulates, ventilates and wicks moisture
- Arch band compresses and stabilizes
- Ergo cushioning

Item	Size	Colour
820000368	XS/S	BLACK
820000369	M/L	BLACK

**\$16<sup>99</sup>** 



## LIV SERENE COMPRESSION

- TransTextura™ moisture transfer technology
- Left and Right specific fit
- Compression varies from 15mm at arch to 12mm at top

Item	Size	Colour
820000374	S	BLACK /PURPLE
820000375	M	BLACK /PURPLE
820000376	L	BLACK /PURPLE

**\$19<sup>99</sup>** 



# LIV GLOVES



## LIV RACE DAY GLOVE

- Longer wrist closure uses elastic instead of Velcro for a secure fit
- Pre-curved thumb construction for ideal fit and mobility
- TransTextura™ fabric

Item	Size	Colour
830000431	S	BLACK STRIPE
830000432	M	BLACK STRIPE
830000433	L	BLACK STRIPE
830000393	S	WHITE STRIPE
830000394	M	WHITE STRIPE
830000395	L	WHITE STRIPE

\$29<sup>99</sup>



## LIV PASSION

- TransTextura™ fabric
- Plush Gel™ multi-thickness foam absorbs road vibrations
- Pre-curved thumb construction for ideal fit and mobility
- Tip Tech™ smart phone operable finger tips

Item	Size	Colour	Type	Price
830000381	S	CORAL	LONG	\$29.99
830000382	M	CORAL	LONG	\$29.99
830000383	L	CORAL	LONG	\$29.99
830000414	S	BLACK	LONG	\$29.99
830000415	M	BLACK	LONG	\$29.99
830000416	L	BLACK	LONG	\$29.99
830000384	S	BLACK	SHORT	\$24.99
830000385	M	BLACK	SHORT	\$24.99
830000386	L	BLACK	SHORT	\$24.99



## LIV HEARTY

- ThermTextura™ fabric
- High visibility reflective accents
- Tip Tech™ smart phone operable finger tips

Item	Size
830000443	S
830000444	M
830000445	L

\$44<sup>99</sup>



## LIV SIGNATURE

- Elastic wrist cuff
- Pre-curved thumb construction for ideal fit and mobility
- Tip Tech™ smart phone operable finger tip

Item	Size	Colour	Type	Price
830000396	S	CORAL	LONG	\$39.99
830000397	M	CORAL	LONG	\$39.99
830000398	L	CORAL	LONG	\$39.99
830000399	S	BLUE	LONG	\$39.99
830000400	M	BLUE	LONG	\$39.99
830000401	L	BLUE	LONG	\$39.99
830000402	S	PURPLE	LONG	\$39.99
830000403	M	PURPLE	LONG	\$39.99
830000404	L	PURPLE	LONG	\$39.99
830000405	S	CORAL	SHORT	\$34.99
830000406	M	CORAL	SHORT	\$34.99
830000407	L	CORAL	SHORT	\$34.99
830000408	S	BLUE	SHORT	\$34.99
830000409	M	BLUE	SHORT	\$34.99
830000410	L	BLUE	SHORT	\$34.99
830000411	S	PURPLE	SHORT	\$34.99
830000412	M	PURPLE	SHORT	\$34.99
830000413	L	PURPLE	SHORT	\$34.99



## LIV ALLURE

- TransTextura™ fabric
- Pre-curved thumb construction for ideal fit and mobility
- Tip Tech™ smart phone operable finger tips

Item	Size	Type	Colour:
830000434	S	LONG	BLACK
830000435	M	LONG	BLACK
830000436	L	LONG	BLACK

\$34<sup>99</sup>



# LIV HELMETS



## LIV REV P

- LiteForm™ webbing for comfort and performance
- Internal Structural Shell (ISS) for strength at reduced weight
- Giant CINCH+™ fit system for simple and easy head-hugging comfort
- 21 vent configuration for optimal airflow and top-of-the-head ventilation
- Proprietary TransTextura Plus™ anti-microbial fast wicking pad technology



**\$159<sup>99</sup>**

Item	Size	Colour
800000147	S	RAPID TURQUOISE
800000148	M	RAPID TURQUOISE
800000149	L	RAPID TURQUOISE
800000150	S	WHITE
800000151	M	WHITE
800000152	L	WHITE

## LIV STREAK S

- Giant CINCH+™ fit system for simple and easy head-hugging comfort
- 19 vent configuration for optimal airflow and top-of-the-head ventilation
- Proprietary TransTextura Plus™ anti-microbial fast wicking pad technology
- Removable Streak visor
- Locking Giant cam-buckles



**\$99<sup>99</sup>**

Item	Size	Colour
800000126	S	TECH BLACK/PURPLE
800000127	M	TECH BLACK/PURPLE
800000128	L	TECH BLACK/PURPLE
800000129	S	TECH WHITE/TURQUOISE
800000130	M	TECH WHITE/TURQUOISE
800000131	L	TECH WHITE/TURQUOISE

## LIV HALO S

- Giant Cinch 5™ Full-Ring fit system for simple and easy adjustability
- 27 vents for optimal airflow and cooling
- In-mold EPS construction with nylon reinforcement
- Removable visor, making it adaptable to all daily riding conditions.
- Locking Giant cam-buckles



**\$79<sup>99</sup>**

Item	Size	Colour
800000109	OSFM	TURQUOISE
800000110	OSFM	BLUE

## LIV PASSION C S

- Giant Cinch 5™ Full-Ring fit system with LED for simple and easy adjustability
- 18 vent configuration for optimal airflow and cooling
- In-mold EPS with reinforced internal nylon strengthening
- Visor included
- Locking Giant cam-buckles



**\$44<sup>99</sup>**

Item	Size	Colour
800000102	OSFM	BLUE
800000103	OSFM	ORANGE

## LIV ALLURE S

- Giant Cinch 5™ Full-Ring fit system for simple and easy adjustability
- 18 vents for optimal airflow and cooling
- In-mold EPS with internal nylon strengthening and under-wrap shell protection, for increased durability and longevity
- 3-point, 12-degree adjustable visor
- Locking Giant cam-buckles



**\$59<sup>99</sup>**

Item	Size	Colour
800000157	OSFM	TURQUOISE
800000158	OSFM	PURPLE





*Elevate  
your ride.*



# LIV SADDLES



## LIV CONTACT



- Women's Dynamic Design for forward or upright riding positions
- Durable synthetic leather cover
- Particle Flow Technology
- 325g

Item	Position	Colour	Weight
120000040	FORWARD	BLACK/GRAY	325g
120000042	UPRIGHT	BLACK/PURPLE	325g



**\$44<sup>99</sup>**

## LIV CONNECT



- Women's Dynamic Design for forward or upright riding positions
- Durable synthetic leather cover
- Particle Flow Technology
- 325g

Item	Position	Colour	Weight
120000045	FORWARD	WHITE/PURPLE	325g
120000046	UPRIGHT	BLACK/GRAY	325g



**\$34<sup>99</sup>**

## LIV FLOW 2 WOMEN'S SADDLE

- Seamless all-weather top
- Lightweight chromoly rails
- Lightweight foam padding
- ZONE Plus multi-density pressure relief

Item	Colour
771103	BLACK



**\$29<sup>99</sup>**

## LIV CONTACT COMFORT+



- Pressure relief D2 base
- Lightweight water resistant seamless synthetic cover
- Center Zone cut
- Tough, durable Chromoly rails

Item
120000036



**\$39<sup>99</sup>**

## LIV CONNECT COMFORT+

- Lightweight water resistant seamless synthetic cover
- Center Zone cut
- Steel rails

Item
120000038



**\$29<sup>99</sup>**

# LIV GRIPS



## LIV SOLE-O MTB GRIP

- Made from soft and durable Kraton rubber
- Custom waved raised surface
- Double-sided lock on

Item	Colour
190000061	BLACK
190000063	PURPLE



\$24<sup>99</sup>



## LIV SILICON GRIP

- Non-slip surface for maximum control
- Super light weight
- Anti-vibration silicon foam absorbs shock and increases comfort

Item	Colour
190000055	BLACK
190000056	GRAY



\$14<sup>99</sup>

# LIV HANDLEBAR TAPE



## LIV CONTACT SLR

- Washable surface
- Integrated EVA absorbs shock and increases comfort
- Durable all condition perforated surface for ventilation
- Includes Giant logo end plugs and Liv/giant finishing tape

Item	Material	Colour
190000043	SYNTHETIC	BLACK/LIGHT BLUE
190000044	SYNTHETIC	WHITE/PINK
190000045	SYNTHETIC	WHITE/APPLE GREEN



\$24<sup>99</sup>

## LIV CONTACT GEL

- Embossed Liv/giant logo
- Non slip suede surface
- Anti vibration Gel absorbs shock for increased comfort
- Includes Giant logo end plugs and Liv/giant finishing tape

Item	Material	Colour
190000041	GEL	PINK
190000042	GEL	AQUA



\$19<sup>99</sup>

# LIV COMPUTERS



## CATENA 9W NEW

Easy to install, easy to use, and available in three trendy colours to match any Liv Bicycle—the Continuum 9 is the perfect computer for your fashion conscious customers who know quality and expect performance.

- 9 function wireless computer: Speed, distance, ride time, average speed, max speed, alarm, odometer, calorie, clock
- Large, easy-to-read display
- Low battery indicator
- Back light

Item	Colour
410000058	WHITE
410000060	BLUE
410000061	PINK

\$39<sup>99</sup>



# LIV LIGHTS



## LIV NYX CLICK+ HL NEW

- 1 Super bright White LED
- Modes: Steady (3hrs)/ Flash (50hrs)
- Li-ion rechargeable battery via Micro USB
- 40 Lumens
- User friendly rubber strap mounting design

Item	Colour
400000084	BLACK
400000087	PURPLE
400000086	BLUE



**\$39<sup>99</sup>**

## LIV NYX CLICK+ TL NEW

- 1 Super bright Red LED
- Modes: Steady (3hrs)/ Flash (50hrs)
- Li-ion rechargeable battery via Micro USB
- 15 Lumens
- User friendly rubber strap mounting design

Item	Colour
400000088	BLACK
400000090	BLUE
400000091	PURPLE



**\$39<sup>99</sup>**

## LIV NYX HL3 NEW

- 3 Super bright White LEDs
- Modes: High/ Mid/ Flash
- Replaceable color top case
- User friendly easy attachment by rubber strap

Item	Colour
400000104	BLACK
400000105	WHITE



**\$19<sup>99</sup>**

## LIV NYX TL3 NEW

- 5 Super bright red LEDs
- Tool-free installation
- Horizontal or vertical position

Item
400000106



**\$14<sup>99</sup>**

## NYX/NYX+ RUBBER STRAP

- Rubber strap for attachment to bicycle

Item	Colour
400000092	HEADLIGHT
400000093	TAILLIGHT



**\$4<sup>99</sup>**

## MOUNT FOR NYX TL3

Item
400000109



**\$4<sup>99</sup>**

# LIV BAGS



## LIV SADDLE BAG NEW

- Innovative silicone straps
- Carbon fiber film overlay for enhanced appearance and durability
- Stretch woven multi-tool pocket with hook and loop closure

Item  
430000039



\$19<sup>99</sup>



## LIV QUICK FIX COMBO KIT

- Everything you need for a quick fix:*
- 12 glueless patches
  - 3 tire levers
  - 9-function multi-tool
  - Seat bag
  - 2 CO<sup>2</sup> cartridges w/Head

Item  
610000051



\$49<sup>99</sup>



# LIV PUMPS



## LIV CONTROL MINI ROAD+

- Lightweight and compact aluminum design
- 18.5mm wide air chamber, delivering Hi-Pressure
- Expandable internal hose with threadable valve for easy pumping

Item  
610000047



\$34<sup>99</sup>



## LIV CONTROL TOWER 2

- Durable brushed Aluminum barrel finish
- Dual valve head, requires no valve head adjustment
- Grip tape base increases stability

Item  
610000048



\$44<sup>99</sup>



# LIV LOCKS



## LIV LECCA CABLE NEW

- Flexible vinyl coated steel cable protects your bicycle's paint
- 2 color options

Item	Colour
520000048	PURPLE
520000050	GREEN

\$19<sup>99</sup>



# LIV WATER BOTTLE CAGES



## LIV AIRWAY CAGE

- Light weight 3K carbon fiber
- 45-degree removal/insertion (right hand)
- Suitable for smaller frames

Item  
490000060



\$59<sup>99</sup>



## LIV PROWAY CAGE

- High flex plastic material
- Open construction is suitable for a wide variety of bottles

Item	Colour
490000064	BLACK/PURPLE
490000065	WHITE/PINK



\$19<sup>99</sup>



## LIV PROWAY SIDE PULL

- High flex plastic material
- 45-degree removal/insertion (right hand)
- Suitable for smaller frames

Item	Colour
490000066	BLACK/PURPLE
490000067	WHITE/PINK



\$19<sup>99</sup>



## LIV GATEWAY CAGE

- Tough, but still flexible alloy cages
- 47g

Item  
490000062



\$6<sup>99</sup>

# LIV WATER BOTTLES



## LIV POUR FAST AUTOSPRING

- Self-sealing silicon valve system
- Dual density wall
- Tapered design
- 100% BPA free tasteless material

Item	Size	Colour	Price
480000014	600ml	PURPLE/BLUE	\$8.99
480000016	600ml	BLUE/ORANGE	\$8.99
480000015	750ml	PURPLE/BLUE	\$9.99
480000017	750ml	BLUE/ORANGE	\$9.99



## LIV POUR FAST EVERCOOL

- Patented, leak proof valve, made by silica gel, no need to close
- Insulated to keep temperature longer
- 100% BPA-Free

Item	Size	Colour	Price
480000033	600ml	CLEAR/LIGHT BLUE	\$14.99



## LIV GOFLO

- Stylish water bottle offered in two sizes and many color options

Item	Size	Colour	Price
480000003	600cc	TRANSPARENT/BLUE	\$3.99
480000004	600cc	TRANSPARENT/PINK	\$3.99
480000005	600cc	BLACK/MAGENTA	\$3.99
480000000	750cc	TRANSPARENT/SILVER	\$4.99
480000001	750cc	TRANSPARENT/PURPLE	\$4.99
480000002	750cc	BLACK/RED	\$4.99







# FRAMESETS



## PROPEL ADVANCED SL ISP

- COLOUR: Matte Composite/Gloss Grey/Red  
 FRAME:
  - Advanced SL-Grade Composite
  - Integrated Seatpost
  - Electronic-Ready
 FORK:
  - Advanced SL-Grade Composite
  - Full-Composite OverDrive 2 Steerer

- INCLUDES:
  - Giant SpeedControl SLR composite brakes
  - RideSense
  - SL Bond-in Top Cap & Steerer Plug w/ Alloy Bolt



SIZE: PART NUMBERS:

S	50090423
M	50090424
M/L	50090425
L	50090426



## PROPEL ADVANCED PRO

- COLOUR: Gloss Blue/White/Black  
 FRAME:
  - Advanced-Grade Composite
  - Electronic-Ready
 FORK:
  - Advanced-Grade Composite
  - Full-Composite OverDrive 2 Steerer

- INCLUDES:
  - Giant SpeedControl SLR composite brakes
  - RideSense
  - SL Bond-in Top Cap & Steerer Plug w/ Alloy Bolt



SIZE: PART NUMBERS:

XS	50090222
S	50090223
M	50090224
M/L	50090225
L	50090226
XL	50090227



## TCX SLR S/S

- COLOUR: Matte Black/Blue  
 FRAME:
  - ALUXX SLR-Grade Aluminum w/ SingleSwing Single Speed-Specific Dropout Design
 FORK:
  - Advanced-Grade Composite
  - Full-Composite OverDrive 2 Steerer
  - 15mm Thru-Axle

- INCLUDES:
  - Giant D-Fuse SL Composite Seatpost
  - DT Swiss 15mm Thru-Axle



SIZE: PART NUMBERS:

S	54090313
M	54090314
M/L	54090315
L	54090316



## ANTHEM ADVANCED 27.5

COLOUR: Matte/Gloss Composite/Cyan  
 FRAME:
 

- Advanced-Grade Composite Front Triangle
- ALUXX SL-Grade Rear Triangle
- 4"/100mm Maestro Suspension
- 142/135mm convertible dropout design

 REAR SHOCK: RockShox Monarch RL



SIZE: PART NUMBERS:  
 S 50090814  
 M 50090815  
 L 50090816



## TRANCE ADVANCED 27.5

COLOUR: Matte/Gloss Composite/Cyan  
 FRAME:
 

- Advanced-Grade Composite Front Triangle
- ALUXX SL-Grade Rear Triangle
- 5.5"/140mm Maestro Suspension
- ISCG-05 tabs
- 142/135mm convertible dropout design

 REAR SHOCK: RockShox Monarch Plus RC3 Debonair



SIZE: PART NUMBERS:  
 S 90091114  
 M 90091115  
 L 90091116  
 XL 90091117



## GLORY 27.5

COLOUR: Brushed Black/Cyan  
 FRAME:
 

- ALUXX SL-Grade Aluminum
- 8"/203mm Maestro Suspension
- ISCG-05 tabs

 REAR SHOCK: RockShox Vivid R2C



SIZE: PART NUMBERS:  
 S 50090514  
 M 50090515  
 L 50090516



GIANT P-SL7

GIANT

ORE  
108

T.S-d

POWERCORE

ULTEGRA



## ON-ROAD/X-ROAD DER. HANGERS

### ROAD DER. HANGER TYPE 1

Item	Compatible with	Colour
115-R1N000EO	1999-01 ALL TCR 1999-01 ALL OCR	SILVER

### ROAD DER. HANGER TYPE 2

Item	Compatible with	Colour
270208	2002-04 PEGASUS 2002-06 ALL TCR 2002-06 ALL OCR EXCEPT OCR TOURING 2006-07 FCR	SILVER

### ROAD DER. HANGER TYPE 3

Item	Compatible with	Colour
470845	2008-09 FCR	BLACK



### ROAD DER. HANGER TYPE 4

Item	Compatible with	Colour
270131	2007-11 TCR ADVANCED SL/ ADV/ALUM/COMP 2011-14 TCR COMPOSITE 2012-14 TCR ALUMINUM 2014-15 TCR SLR 2009-11 DEFY ADV/ALUM 2012 DEFY COMPOSITE 2012 RAPID COMPOSITE 2010-13 RAPID 2010-13 DASH 2011-13 TCX ADV SL	BLACK

Item	Colour	Notes
270914	RED	*REMAINING STOCK*
270915	BLUE	*REMAINING STOCK*
270916	GREY	*REMAINING STOCK*

### ROAD DER. HANGER TYPE 5

Item	Compatible with	Colour
1159-RE2NAA-01	2007-08 TCR ALLIANCE/ ALUMINUM 2007-08 ALL OCR 2008-09 FCR ALLIANCE 2009-11 DEFY ALUMINUM/ALLIANCE 2009-11 AVAIL ALUMINUM/ALLIANCE 2009-13 TCX	BLACK



### ROAD DER. HANGER TYPE 6

Item	Compatible with	Colour
271200	2012+ TCR ADV SL/ADV 2012+ DEFY ADV SL/ADV/ALU 2013-14 DEFY COMPOSITE 2012+ AVAIL ADV SL/ADV/ALU 2013-14 AVAIL COMPOSITE 2013 RAPID COMPOSITE 2014+ PROPEL ADV SL/ADV 2014 ESCAPE RX COMPOSITE 2014-15 TCX ADVANCED/SLR 2014+ REVOLT 2014+ ANYROAD ALU/COMAX 2014+ ENVIE ADV 2014+ BRAVA SLR 2014+ INVITE ALU/ COMAX 2015 FASTROAD COMAX/SLR	BLACK

### TRINITY DER. HANGER

Item	Compatible with	Colour
270926	2010+ TRINITY ADV SL 2012+ TRINITY COMPOSITE	BLACK



### OUTBOARD DER. HANGER\*

Item	Compatible with	Colour
470848	2003-06 OCR TOURING 2005-08 TCX 2009 SEEK TRAN SEND TRAN SPORT ESCAPE CYPRESS VIA SUEDE EXPRESSWAY SEDONA 2012-13 ROAM 2013+ ROVE PRODIGY REVIVE 2015 ALIGHT	BLACK

\*Rack mount hole included



### INBOARD DER. HANGER

Item	Compatible with	Colour
270766	2010-13 SEEK 2011+ ROAM XR 2014+ ROAM	BLACK

### 97/98 TCR/CFR/PELETON DER. HANGER

Item	Compatible with	Colour
183262	1997-98 TCR 1997-98 CFR 1997-98 PELETON	BLACK

# OFF-ROAD DER. HANGERS



## INBOARD DER. HANGER

Item	Compatible with	Colour
270766	2005-06 XTC COMPOSITE 2007-08 ANTHEM ADV 2009+ ANTHEM X ALUMINUM/ADV/29er 2008 TRANCE 2008-13 TRANCE X ALUMINUM/ADV/ 29er 2008-13 REIGN 2008-10 XTC ALLIANCE 2009-10 XTC ADV 2010-13 XTC ALUMINUM 2011+ XTC 29er ALUMINUM/ COMPOSITE 2010 RAINIER 2014+ TALON 27.5 2009-12 BRASS 2009-13 ANTHEM X WOMEN 2012-13 TRANCE X WOMEN CYPHER 2014+ TEMPT 27.5 2014+ ENCHANT 2015 STANCE	BLACK

Item	Colour
270927	BLUE
270928	RED
270929	GREY



## OUTBOARD DER. HANGER\*

Item	Compatible with	Colour
470848	2006-08 ANTHEM 2005-07 TRANCE 2007-08 TRANCE ADV 2005-07 REIGN 2007-09 REIGN X 2004-10 STP 2003-09 XTC 2012-13 TALON 29er 2013 REVEL 29er 2011+ REVEL YUKON RINCON BOULDER IGUANA ALL NRS VT AC PISTOL WARP 2007-08 ANTHEM WOMEN 2008-09 ARETE	BLACK

\*Rack mount hole included



## DER. HANGER 135/5 DRIVE SIDE ONLY

Item	Compatible with	Colour
1159-RE215A-R03	2014+ ALL ANTHEM 27.5 2014+ ALL TRANCE 27.5 2015 ALL REIGN 27.5 2014+ ALL XTC 27.5 2014+ ALL LUST 27.5 2014+ ALL INTRIGUE 27.5	BLACK

## DER. HANGER 142/12 DRIVE SIDE ONLY

Item	Compatible with	Colour
1159-RE2150-R04	2014+ ALL ANTHEM 27.5 2014+ ALL TRANCE 27.5 2015 ALL REIGN 27.5 2014+ ALL XTC 27.5 2014+ ALL LUST 27.5 2014+ ALL INTRIGUE 27.5	GOLD



## DER. HANGER CONVERSION KIT 135/5

Item	Compatible with	Colour
1280GS834609A1	2014+ ALL ANTHEM 27.5 2014+ ALL TRANCE 27.5 2015 ALL REIGN 27.5 2014+ ALL XTC 27.5 2014+ ALL LUST 27.5 2014+ ALL INTRIGUE 27.5	BLACK

## DER. HANGER CONVERSION KIT 142/12

Item	Compatible with	Colour
1280GS834609B1	2014+ ALL ANTHEM 27.5 2014+ ALL TRANCE 27.5 2015 ALL REIGN 27.5 2014+ ALL XTC 27.5 2014+ ALL LUST 27.5 2014+ ALL INTRIGUE 27.5	GOLD

## 10+ FAITH DER. HANGER RC445

Item	Compatible with	Colour
1280GS014A13C5	2010-13 FAITH	BLACK
270942	2010-13 FAITH	BLUE
270943	2010-13 FAITH	GOLD

## 10+ FAITH DER. HANGER RC442

Item	Compatible with	Colour
1280GS014A12C8	2010-13 FAITH	BLACK
270944	2010-13 FAITH	BLUE
270941	2010-13 FAITH	GOLD

## 10+ GLORY DER. HANGER

Item	Compatible with	Colour
1280GS024512D8	2010+ GLORY	BLACK
270924	2010+ GLORY	BLUE
270925	2010+ GLORY	RED

## 10 REIGN X DER. HANGER

Item	Compatible with	Colour
270920	2010-14 REIGN X	BLACK
270921	2010-14 REIGN X	*REMAINING STOCK*
270922	2010-14 REIGN X	*REMAINING STOCK*
270923	2010-14 REIGN X	*REMAINING STOCK*

## 06-09 GLORY/GLORY DH 12MM THRU DER. HANGER

Item	Compatible with	Colour
270605	2006-09 GLORY	BLACK

## 05-06 FAITH DER. HANGER

Item	Compatible with	Colour
270133	2005-06 FAITH	BLACK

## 11 STP SS DER. HANGER

Item	Side	Compatible with	Colour
271004	LEFT	2011-13 STP	SILVER
271005	RIGHT*	2011-13 STP	SILVER

\*Drive Side Der. Conversion

## CFM/MCM DER. HANGER\*

Item	Compatible with	Colour
183260	CFM-MCM	SILVER

\*Drive side only

## FRONT MOUNT PLATES



### FRONT DER. MOUNT PLATE TYPE 1

Item	Compatible with	Colour
310201	1998-09 ALL TCR 1998-09 ALL OCR 2009 TCR ALUMINUM 2009 TCR ALLIANCE 2009-14 DEFY 2009 TRINITY ALU 2008-09 FCR ALLIANCE 2009-13 RAPID 2009 AERYN ALU 2009-14 AVAIL 2009-13 DASH	BLACK



### FRONT DER. MOUNT PLATE TYPE 2

Item	Compatible with	Colour
470842	2009+ TCR ADV SL 2010 TCR ALLIANCE 2011 TCR ALUMINUM 2014+ TCR SLR 2015 DEFY ADV SL/ADV/ALU 2015 AVAIL ADV SL/ADV/ALU 2015 FASTROAD ALU/COMAX	BLACK



### FRONT DER. MOUNT PLATE TYPE 3

Item	Compatible with	Colour
470843	2009+ TCR ADVANCED 2011-14 TCR COMPOSITE 2009-14 DEFY ADVANCED 2012-14 DEFY COMPOSITE 2010 DEFY ALLIANCE 2012-14 DEFY ADV SL 2010+ TRINITY ADV SL 2012+ TRINITY COMPOSITE 2011-13 TCX ADV SL 2012-13 RAPID COMPOSITE 2010-14 AVAIL ADV 2012-14 AVAIL COMPOSITE 2014+ PROPEL ADV SL/ ADV 2014 ESCAPE RX COMPOSITE 2014+ ENVIE ADV 2015 INVITE COMAX	BLACK

### FRONT DER. MOUNT PLATE 2014+ TCX

Item	Compatible with	Colour
1643-WG34B0-401	2014+ TCX ADV/SLR	BLACK

### FRONT DER. MOUNT PLATE TT/TRINITY/AERYN

Item	Compatible with	Colour
1643-WG3000-01	2007-09 TRINITY ALLIANCE 2008-09 AERYN ALLIANCE	BLACK

## HEAD SETS

Item	Compatible with	Price
490800	HEADSET – ECONOMY, AHEAD, NO-CUP DESIGN, ZERO STACK TAPERED 1 1/4" - 1 1/8"	\$33.99
490201	HEADSET – FSA ORBIT IS, AHEAD, NO-CUP DESIGN, ZERO STACK 1 1/8"	\$39.99
490202	HEADSET – FSA ORBIT Z, AHEAD, PRESSED-CUP DESIGN, ZERO STACK 1 1/8"	\$59.99
490900	HEADSET – OVERDRIVE ROAD, COMPOSITE CONICAL TOP CAP	\$49.99
490901	HEADSET – OVERDRIVE MTN, ALUMINUM CONICAL TOP CAP	\$49.99
491200	OD2 ROAD BIKE HEADSET 1 1/4" - 1 1/2"	\$49.99
1310-N051AA-203/ 160000002	OD2 MTB BIKE HEADSET 1 1/4" - 1 1/2"	\$49.99
1310-N057AA-02	2010+ GLORY HEADSET	\$49.99

## FRAME PROTECTORS

Item	Description	Price
240000002	CHAIN STAY PROTECTOR FOR XTC 27.5 / XTC ADV 27.5	\$11.99
240000003	CHAIN STAY PROTECTOR FOR ANTHEM 27.5 / ANTHEM ADV 27.5	\$11.99
240000004	CHAIN STAY PROTECTOR TRANCE 27.5 / TRANCE ADV 27.5 / INTRIGUE 27.5	\$11.99
3G9-6005-1	CHAIN STAY PROTECTOR FOR REIGN 27.5 / REIGN ADV 27.5	\$11.99
3G9-6006-1	CHAIN STAY PROTECTOR FOR GLORY 27.5	\$11.99
240000000	DOWN TUBE PROTECTOR FOR XTC ADV 27.5 / OBSESS ADV 27.5	\$5.99
240000001	DOWN TUBE PROTECTOR FOR ANTHEM ADV 27.5 / TRANCE ADV 27.5 / LUST ADV 27.5	\$5.99
3G9-4003-1	DOWN TUBE PROTECTOR FOR REIGN ADV 27.5 / REIGN 27.5	\$5.99
3G9-4004-1	DOWN TUBE PROTECTOR FOR GLORY 27.5	\$5.99

## WHEEL ACCESSORIES

Item	Description	Price
731117	ON-ROAD SKEWER SET	\$69.99
350000016	OFF-ROAD SKEWER SET	\$69.99
300000002	MY14+ TCX FORK AXLE, 100/15MM	\$39.99
300000003	12X142MM THRU-AXLE	\$39.99
300000004	5X135MM REAR SKEWER	\$19.99
300000005	FREEHUB BODY SRAM XX1	\$129.99
300000008	FREEHUB BODY SRAM XX1 WITH 5X135MM DRIVE SIDE END CAP	\$139.99
1581-DTTUBE-301	TUBELESS CONVERSION KIT FOR 29er	\$119.99/each
1581-DTTUBE-302	TUBELESS CONVERSION KIT FOR 26	\$119.99/each

## SEAT POST CLAMPS

Item	Description	Price
150000029	MY14+ TCX SLR SEATPOST CLAMP	\$11.99
150000030	MY14+ TCX ADV SEATPOST CLAMP	\$9.99
751200	2009-20014 DEFY/AVAIL SEATPOST CLAMP INTEGRATED RACK MOUNT	\$9.99
1722-G2SC01-201	2009+ TCR ADV / DEFY ADV / AVAIL ADV SEATPOST CLAMP	\$30
1722-GANTHE-02	CARBON MTB BIKE SEATPOST CLAMP (ANTHEM ADV / TRANCE ADV / REIGN ADV)	\$20

# MAESTRO SUSPENSION KITS

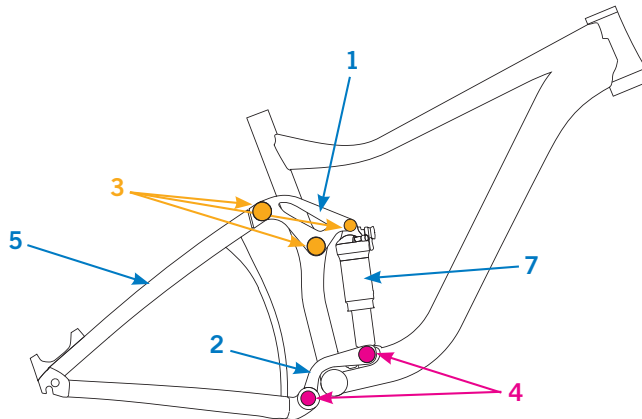

## MODEL YEAR 2015

Dia #	Description	Anthem X ADV 29er	Anthem X 29er	Anthem ADV 27.5 0 Team	Anthem ADV 27.5 1	Anthem ADV 27.5 2	Anthem ADV 27.5 SX	Anthem 27.5 1	Anthem 27.5 2
1	Upper Rocker Arm	1280GS800209B1	1280GS804R40A8	1280GS801802B6	1280GS801802A0	1280GS801802C2	1280GS801801D6	1280GS804V02A5	1280GS804V02D1
2	Lower Ulink	1280GS800210B0	1280GS804R41A5	1280GS801801C2	1280GS801801A0	1280GS801801C2	1280GS801802D6	1280GS804V01A8	1280GS804V01D2
3	Upper bolt/bearing kit	1280GS800214A7	1280GS804R45A4	1280GS804V06A4	1280GS801806A0	1280GS804V06A4	1280GS801806A0	1280GS804V06A4	1280GS804V06A4
4	Lower bolt/bearing kit	1280GS800215A7	1280GS804R47A9	1280GS804T07A0	1280GS804T07A0	1280GS804T07A0	1280GS804T07A0	1280GS804T07A0	1280GS804T07A0
5	Rear Swingarm	90R15G90467A4	90R15G90462A8	90R15G90437A5	90R15G90442A5	90R15G90447A1	90R15G90452A1	90R15G90422A2	90R15G90427A9

Dia #	Description	Anthem 27.5 3	Anthem 27.5 SX	Trance ADV 27.5 0	Trance ADV 27.5 1	Trance ADV 27.5 2	Trance 27.5 1	Trance 27.5 2	Trance 27.5 3
1	Upper Rocker Arm	1280GS804V02B3	1280GS804V02C1	1280GS831101A1	1280GS831101B1	1280GS831101C1	1280GS834801A1	1280GS834801B1	1280GS834801C1
2	Lower Ulink	1280GS804V01B6	1280GS804V01C4	1280GS831104A1	1280GS831104B1	1280GS831104C1	1280GS834804A1	1280GS834804B1	1280GS834804C1
3	Upper bolt/bearing kit	1280GS804V06A4	1280GS804V06A4	1280GS831003A1	1280GS831003A1	1280GS831003A1	1280GS834603A1	1280GS834603A1	1280GS834603A1
4	Lower bolt/bearing kit	1280GS804T07A0	1280GS804T07A0	1280GS834606A1	1280GS834606A1	1280GS834606A1	1280GS834606A1	1280GS834606A1	1280GS834606A1
5	Rear Swingarm	90R15G90432A9	90R15G90457A8	90R15G90472A6	90R15G90477A2	90R15G90482A2	90R15G90515A5	90R15G90520A5	90R15G90525A1

Dia #	Description	Trance SX 27.5	Reign ADV 27.5 0 Team	Reign ADV 27.5 1	Reign 27.5 1	Reign 27.5 2	Glory 27.5 0	Glory 27.5 1	Glory 27.5 2
1	Upper Rocker Arm	1280GS834801E1	1280GS034F01D1	1280GS034F01C1	1280GS034F01A1	1280GS034F01B1	1280GS024701A0	1280GS024701B9	1280GS024701C7
2	Lower Ulink	1280GS834604E1	1280GS034F04D1	1280GS034F04C1	1280GS034F04A1	1280GS034F04B1	1280GS024703A5	1280GS024703A5	1280GS024703A5
3	Upper bolt/bearing kit	1280GS834603A1	1280GS034F03A1	1280GS034F03A1	1280GS034F03A1	1280GS034F03A1	1280GS024705A1	1280GS024705A1	1280GS024705A1
4	Lower bolt/bearing kit	1280GS834606A1	1280GS034F06A1	1280GS034F06A1	1280GS034F06A1	1280GS034F06A1	1280GS024706A7	1280GS024706A7	1280GS024706A7
5	Rear Swingarm	90R15G90530A3	90R15G90414A0	90R15G90418A1	90R15G90406A0	90R15G90410A1	90R15G90388A9	90R15G90392A1	90R15G90396A0

Dia #	Description	Lust ADV 27.5 0	Lust ADV 27.5 2	Lust 27.5 1	Lust 27.5 2	Intrigue 27.5 1	Intrigue 27.5 2
1	Upper Rocker Arm	1280GS801902D8	1280GS801902A1	1280GS804W02C7	1280GS804W02B9	1280GS834901A1	1280GS834901B1
2	Lower Ulink	1280GS801901D0	1280GS801901A1	1280GS804W01C1	1280GS804W01B1	1280GS834904A1	1280GS834904B1
3	Upper bolt/bearing kit	1280GS801906A1	1280GS801906A1	1280GS804W06B1	1280GS804W06B1	1280GS834903A1	1280GS834903B1
4	Lower bolt/bearing kit	1280GS801907A1	1280GS801907A1	1280GS804W07B1	1280GS804W07B1	1280GS834906A1	1280GS834906B1
5	Rear Swingarm	90R15G90499A8	90R15G90503A2	90R15G90487A7	90R15G90491A1	90R15G90507A3	90R15G90511A6

## MODEL YEAR 2014

Dia #	Description	Anthem X ADV 29 1	Anthem X ADV 29 2	Anthem X29 2	Anthem X29 3	Anthem ADV 27.5 1	Anthem ADV 27.5 2	Anthem 27.5 1	Anthem 27.5 2
1	Upper Rocker Arm	1280GS800209A1	1280GS800205A1	1280GS804R01E2	1280GS804R01F0	1280GS801602C3	1280GS801602B5	1280GS804T02A4	1280GS804T02B2
2	Lower Ulink	1280GS800210A2	1280GS800206A2	1280GS804R02E1	1280GS804R02F8	1280GS801601A1	1280GS801601A1	1280GS804T01A7	1280GS804T01B5
3	Upper bolt/bearing kit	1280GS800214A7	1280GS804P10A8	1280GS804P10A8	1280GS804P10A8	1280GS801606B4	1280GS801606A6	1280GS804T06A3	1280GS804T06A3
4	Lower bolt/bearing kit	1280GS800215A7	1280GS804P12A2	1280GS804P12A2	1280GS804P12A2	1280GS801607A3	1280GS804T07A0	1280GS804T07A0	1280GS804T07A0
5	Rear Swingarm	90R14G91534A6	90R14G90539A8	90R14G90524A5	90R14G90529A1	90R14G90509A9	90R14G90514A9	90R14G90489A4	90R14G90494A4

Dia #	Description	Anthem 27.5 3	Trance X29 0	Trance X29 1	Trance X29 2	Trance ADV 27.5 1	Trance ADV 27.5 2	Trance 27.5 1	Trance 27.5 2
1	Upper Rocker Arm	1280GS804T02C0	1280GS834511B1	1280GS834511A1	1280GS834511C1	1280GS831001C1	1280GS831001B1	1280GS834601A1	1280GS834601B1
2	Lower Ulink	1280GS804T01A7	1280GS834514B1	1280GS834514A1	1280GS834514C1	1280GS831004C1	1280GS831004B1	1280GS834604A1	1280GS834604B1
3	Upper bolt/bearing kit	1280GS804T06A3	1280GS834513A1	1280GS834513A1	1280GS834503A1	1280GS831003B1	1280GS831003A1	1280GS834603A1	1280GS834603A1
4	Lower bolt/bearing kit	1280GS804T07A0	1280GS834516A1	1280GS834516A1	1280GS834506A1	1280GS834606B1	1280GS834606A1	1280GS834606A1	1280GS834606A1
5	Rear Swingarm	90R14G90499A0	90R14G90632A4	90R14G90637A0	90R14G90642A0	90R14G90549A6	90R14G90554A6	90R14G90607A1	90R14G90612A1

Dia #	Description	Trance 27.5 3	Trance 27.5 4	Trance ADV SX 27.5	Trance SX 27.5	Reign X1	Glory 0	Glory 2
1	Upper Rocker Arm	1280GS834601C1	1280GS834601E1	1280GS831001C1	1280GS834601D1	1280GS034B01K5	1280GS024601D1	1280GS024601C1
2	Lower Ulink	1280GS834604C1	1280GS834604E1	1280GS831004C1	1280GS834604D1	1280GS034B02G3	1280GS024608C2	1280GS024608B4
3	Upper bolt/bearing kit	1280GS834603B1	1280GS834603A1	1280GS831003B1	1280GS834603B1	1280GS034B10C2	1280GS024527C2	1280GS024527C2
4	Lower bolt/bearing kit	1280GS834606B1	1280GS834606A1	1280GS834606B1	1280GS834606B1	1280GS034B12C7	1280GS024526C5	1280GS024526C5
5	Rear Swingarm	90R14G90617A8		90R14G90622A8	90R14G90627A4	90R14G90485A5	90R14G90465A2	90R14G90473A4
7	Rear shock		12814GE0112A1					

Dia #	Description	Lust ADV 27.5 2	Lust 27.5 2	Intrigue 27.5 1	Intrigue 27.5 2
1	Upper Rocker Arm	1280GS801702B0	1280GS804U02B8	1280GS834701A1	1280GS834701B1
2	Lower Ulink	1280GS801701B3	1280GS804U01B0	1280GS834704A1	1280GS834704B1
3	Upper bolt/bearing kit	1280GS801706B1	1280GS804T06A3	1280GS834703A1	1280GS834603A1
4	Lower bolt/bearing kit	1280GS801707B7	1280GS804T07A0	1280GS834706A1	1280GS834606A1
5	Rear Swingarm	90R14G90575A4	90R14G90563A3	90R14G90599A8	90R14G90603A2

## MODEL YEAR 2013

Dia #	Description	Anthem X 1	Anthem X 2	Anthem X ADV 29 0	Anthem X ADV 29 1	Anthem X ADV 29 2	Anthem X29 1	Anthem X29 2	Anthem X29 4
1	Upper Rocker Arm	1280GS804P30A0	1280GS804P30A0	1280GS824509A3	1280GS800201A3	1280GS800201A3	1280GS804R30A1	1280GS804R30A1	1280GS804R30A1
2	Lower Ulink	1280GS804P02B4	1280GS804P02B4	1280GS800201A3	1280GS800202A0	1280GS800202A0	1280GS804R21B0	1280GS804R21B0	1280GS804R21B0
3	Upper bolt/bearing kit	1280GS804P35A7	1280GS804P10A8	1280GS804P10A8	1280GS804P10A8	1280GS804P10A8	1280GS804P10D2	1280GS804P10A8	1280GS804P10A8
4	Lower bolt/bearing kit	1280GS804P36A4	1280GS804P12A2	1280GS804P12A2	1280GS804P12A2	1280GS804P12A2	1280GS804P12D7	1280GS804P12A2	1280GS804P12A2
5	Rear Swingarm	90R13G90785A4	90R13G90779A7	90R13G90844A7	90R13G90832A6	90R13G90826A9	90R13G90814A8	90R13G90808A0	90R13G90796A8

Dia #	Description	Trance X ADV	Trance X 1	Trance X 2	Trance X 3	Trance X29 0	Trance X29 1	Trance X29 2
1	Upper Rocker Arm	1280GS834313A1	1280GS834313A1	1280GS834313A1	1280GS834313A1	1280GS834501A1	1280GS834501A1	1280GS834501A1
2	Lower Ulink	1280GS834304C1	1280GS834304C1	1280GS834304C1	1280GS834304C1	1280GS834504A1	1280GS834504A1	1280GS834504A1
3	Upper bolt/bearing kit	1280GS834303F1	1280GS834303F1	1280GS834303F1	1280GS834303C1	1280GS834503A1	1280GS834503B1	1280GS834503A1
4	Lower bolt/bearing kit	1280GS834306F1	1280GS834306F1	1280GS834306F1	1280GS834306C1	1280GS834506A1	1280GS834506B1	1280GS834506A1
5	Rear Swingarm	90R13G90A24A6	90R13G90A01A5	90R13G90A06A8	90R13G90A11A8	90R13G90A32A1	90R13G90A37A4	90R13G90A42A4
7	Rear Shock	12812GU0001A5						

Dia #	Description	Reign 0	Reign 1	Reign 2	Reign X1	Reign X2	Glory 0	Glory 1	Glory 2
1	Upper Rocker Arm	1280GS034D01A1	1280GS034D01A1	1280GS034D01A1	1280GS034B01I2	1280GS034B01I2	1280GS024601A5	1280GS024601A5	1280GS024601B3
2	Lower Ulink	1280GS034D04A1	1280GS034D04A1	1280GS034D04A1	1280GS034B02D9	1280GS034B02D9	1280GS024502A7	1280GS024502A7	1280GS024502A7
3	Upper bolt/bearing kit	1280GS034D03A1	1280GS034D03B1	1280GS034D03C1	1280GS034B10E9	1280GS034B10F7	1280GS024606A1	1280GS024527C2	1280GS024527B4
4	Lower bolt/bearing kit	1280GS034D06A1	1280GS034D06B1	1280GS034D06C1	1280GS034B12E3	1280GS034B12F1	1280GS024607A9	1280GS024526C5	1280GS024526B7
5	Rear Swingarm	90R13G90A52A0	90R13G90A57A7	90R13G90A62A7	90R13G90A75A5	90R13G90A79A4	90R13G90A83A7	90R13G90A91A9	90R13G90A87A1

Dia #	Description	Anthem X W	Anthem X29 0 W	Anthem X29 4 W	Trance X 1 W	Trance X 2 W
1	Upper Rocker Arm	1280GS804P20J4	1280GS804S01A1	1280GS804S01B1	1280GS834406A1	1280GS834406B1
2	Lower Ulink	1280GS804P21D6	1280GS804S02A9	1280GS804S02B7	1280GS834408A1	1280GS834408B1
3	Upper bolt/bearing kit	1280GS804Q10A3	1280GS804P10A8	1280GS804R10C5	1280GS834303A2	1280GS834303F1
4	Lower bolt/bearing kit	1280GS804Q12A8	1280GS804P12A2	1280GS804R12C1	1280GS834306A4	1280GS834306F1
5	Rear Swingarm	90R13G90768A3	90R13G90855A0	90R13G90850A4	90R13G90A16A8	90R13G90A20A9

## MODEL YEAR 2012

Dia #	Description	Glory 0	Glory 2	Faith 0	Anthem X3	Anthem X1	Anthem X1 W	Anthem X ADV SL 0	Anthem X ADV 1
1	Upper Rocker Arm	1280GS024530A1	1280GS024530B1	1280GS014A01E4	1280GS804P20D9	1280GS804P20B2	1280GS804P20G3	1280GS800101E0	1280GS801501A4
2	Lower Ulink	1280GS024502A7	1280GS024502A7	1280GS014A02C1	1280GS804P02B4	1280GS804P02B4	1280GS804P21B1	1280GS800102C1	1280GS804P02B4
3	Upper bolt/bearing kit	1280GS024527A6	1280GS024527B4	1280GS014A09E2	1280GS804P10A8	1280GS804P10C4	1280GS804Q10A3	1280GS800109B4	1280GS804P10C4
4	Lower bolt/bearing kit	1280GS024526A9	1280GS024526B7	1280GS014A11E0	1280GS804P12A2	1280GS804P12C9	1280GS804Q12A8	1280GS800111B2	1280GS804P12C9
5	Rear Swingarm	90R12GV0151A1	90R12GV0148A6	90R12GV0145A1	90R12GV0031A3	90R12GV0036A1	90R12GV0041A1	90R12GV0048A0	90R12GV0044A1

Dia #	Description	Anthem X29 0	Anthem X29 1	Anthem X29 2	Trance X4	Trance X3	Trance X1	Trance X2 W	Trance X ADV 1
1	Upper Rocker Arm	1280GS804R20A5	1280GS804R20A5	1280GS804R20A5	1280GS834311G1	1280GS834311F1	1280GS834311D1	1280GS834401D1	1280GS834303D1
2	Lower Ulink	1280GS804R21A2	1280GS804R21A2	1280GS804R21A2	1280GS834304C1	1280GS834304C1	1280GS834304C1	1280GS834404D1	1280GS834306D1
3	Upper bolt/bearing kit	1280GS804P10C4	1280GS804P10C4	1280GS804P10C4	1280GS834303B1	1280GS834303D1	1280GS834303D1	1280GS834303A2	1280GS834303A2
4	Lower bolt/bearing kit	1280GS804P12C9	1280GS804P12C9	1280GS804P12C9	1280GS834306B1	1280GS834306D1	1280GS834306D1	1280GS834306A4	1280GS834306A4
5	Rear Swingarm	90R12GV0060A5	90R12GV0056A2	90R12GV0052A3	90R12GV0283A4	90R12GV0288A3	90R12GV0293A0	90R12GV0305A6	90R12GV0298A5
7	Rear Shock	12812GU0001A5							

Dia #	Description	Trance X ADV SL 0	Reign 2	Reign 1	Reign 0	Reign SX 1	Reign X0	Reign X1	Reign X2
1	Upper Rocker Arm	1280GS820101E1	1280GS034C01C9	1280GS034C01C9	1280GS034C01B0	1280GS034B01G6	1280GS034B01E1	1280GS034B01H4	1280GS034B01F8
2	Lower Ulink	1280GS820104E1	1280GS034C02A1	1280GS034C02A1	1280GS034C02A1	1280GS034B02D9	1280GS034B02D9	1280GS034B02D9	1280GS034B02D9
3	Upper bolt/bearing kit	1280GS820103D1	1280GS034C10B1	1280GS034C10B1	1280GS034C10B1	1280GS034B10C2	1280GS034B10B4	1280GS034B10B4	1280GS034B10B4
4	Lower bolt/bearing kit	1280GS820106D1	1280GS034C12B4	1280GS034C12B4	1280GS034C12B4	1280GS034B12C7	1280GS034B12B9	1280GS034B12B9	1280GS034B12B9
5	Rear Swingarm	90R12GV0302A4	90R12GV0155A0	90R12GV0160A0	90R12GV0165A7	90R12GV0169A6	90R12GV0182A8	90R12GV0177A8	90R12GV0172A1

## MODEL YEAR 2011

Dia #	Description	Anthem X SL0	Anthem X 1	Anthem X 2	Anthem X4	Anthem X 29 1	Anthem X 29 3	Trance X SL 0	Trance X 1
1	Upper Rocker Arm	1280GS800101B6	1280GS804P01B7	1280GS804P01A9	1280GS804P01D3	1280GS804R01A1	1280GS804R01C6	1280GS820101D1	1280GS834301D1
2	Lower Ulink	1280GS800102B3	1280GS804P02B4	1280GS804P02A6	1280GS804P02D0	1280GS804R02A7	1280GS804R02C3	1280GS820104D1	1280GS834304C1
3	Upper bolt/bearing kit	1280GS800109B4	1280GS804P10B6	1280GS804P10A8	1280GS804P10B6	1280GS804R10A9	1280GS800109B4	1280GS820103D1	1280GS834303C1
4	Lower bolt/bearing kit	1280GS800111B2	1280GS804P12B0	1280GS804P12A2	1280GS804P12B0	1280GS804R12A3	1280GS804R12C1	1280GS820106D1	1280GS834306C1
5	Rear Swingarm	90R11GV0039A4	90R11GV0034A8	90R11GV0029A8	90R11GV0344A0	90R11GV0050A1	90R11GV0046A9	90R11GV0074A3	90R11GV0069A7

Dia #	Description	Trance X 2	Trance X 3	Trance X 4	Reign 0	Reign 1	Reign 2	Reign X 0	Reign X 1
1	Upper Rocker Arm	1280GS834301B1	1280GS834301A8	1280GS834301C1	1280GS034C01A2	1280GS034C02A1	1280GS034C01A2	1280GS034B01C3	1280GS034B01B5
2	Lower Ulink	1280GS834304B1	1280GS834304A1	1280GS834304C1	1280GS034C02A1	1280GS034C10A1	1280GS034C02A1	1280GS034B02C0	1280GS034B02B2
3	Upper bolt/bearing kit	1280GS834303B1	1280GS834303A2	1280GS834303C1	1280GS034C10A1	1280GS034C12A6	1280GS034C10A1	1280GS034B10C2	1280GS034B10B4
4	Lower bolt/bearing kit	1280GS834306B1	1280GS834306A4	1280GS834306C1	1280GS034C12A6	90R11GV0088A9	1280GS034C12A6	1280GS034B12C7	1280GS034B12B9
5	Rear Swingarm	90R11GV0064A0	90R11GV0059A7	90R11GV0054A0	90R11GV0093A9	90R11GV0050A1	90R11GV0083A2	90R11GV0108A3	90R11GV0103A7
7	Rear Shock	12809GU0003A4							

Dia #	Description	Reign X 2	Reign S X	Faith 0	Faith 1	Glory 0	Glory 1	Anthem X2 W	Cypher 1	Cypher 2
1	Upper Rocker Arm	1280GS034B01D1	1280GS034B01A7	1280GS014A01C4	1280GS014A01D4	1280GS024520A5	1280GS024520B3	1280GS804Q01B2	1280GS834401B1	1280GS834401A3
2	Lower Ulink	1280GS034B02B2	1280GS034B02C0	1280GS014A02C1	1280GS014A02A1	1280GS024502A7	1280GS024502A7	1280GS804Q02B1	1280GS834404B1	1280GS834404A5
3	Upper bolt/bearing kit	1280GS034B10C2	1280GS034B10C2	1280GS014A09C2	1280GS014A09D2	1280GS024524A4	1280GS024524B2	1280GS804Q10A3	1280GS834303F1	1280GS834303A2
4	Lower bolt/bearing kit	1280GS034B12C7	1280GS034B12C7	1280GS014A11C0	1280GS014A11D0	1280GS024526A9	1280GS024526B7	1280GS804Q12A8	1280GS834306F1	1280GS834306A4
5	Rear Swingarm	90R11GV0098A5	90R11GV0112A6	90R11GV0119A1	90R11GV0116A1	90R11GV0125A4	90R11GV0122A2	90R11GV0043A7	90R11GV0080A0	90R11GV0077A5

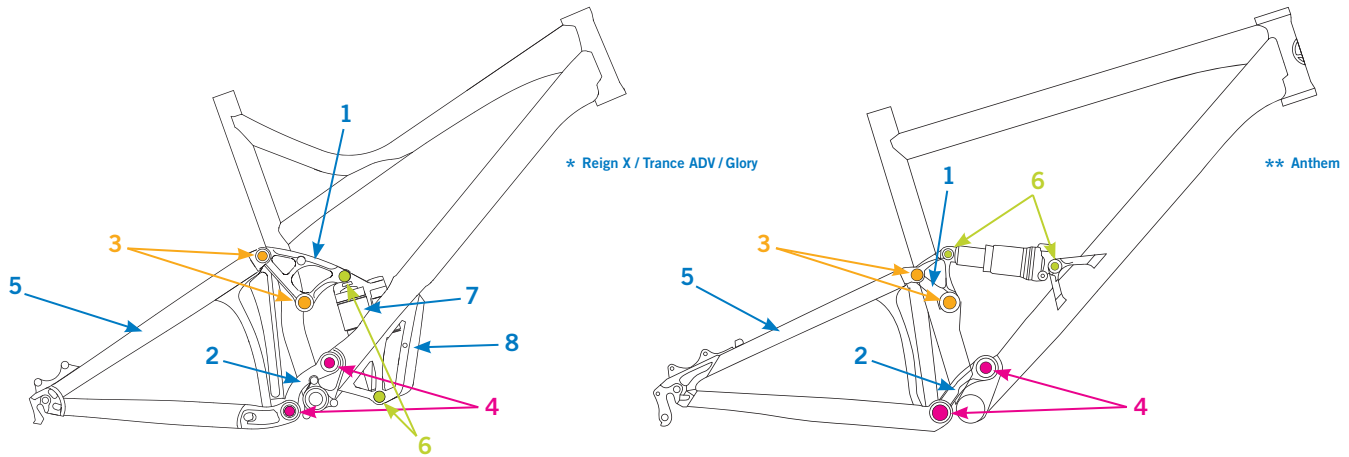

## MODEL YEAR 2010

Dia #	Description	Anthem X SLO	Anthem X 1	Anthem X 2	Anthem X3	Anthem X4	Trance X SL 0	Trance X1	Trance X 2
1	Upper Rocker Arm	1280GS800101A8	1280GS804M01H1	1280GS804M01G1	1280GS804M01H1	1280GS804M01H1	1280GS820101A1	1280GS834001E4	1280GS834001G0
2	Lower Ulink	1280GS800102A5	1280GS804M02H7	1280GS804M02G9	1280GS804M02H7	1280GS804M02H7	1280GS820104A7	1280GS834004E1	1280GS834004G1
3	Upper bolt/bearing kit	1280GS800109A6	1280GS804M10A1	1280GS804M10A1	1280GS804M10A1	1280GS804M10A1	1280GS820103A4	1280GS834003A4	1280GS834003A4
4	Lower bolt/bearing kit	1280GS800111A4	1280GS804M12A6	1280GS804M12A6	1280GS804M12A6	1280GS804M12A6	1280GS820106A6	1280GS834006A6	1280GS834006A6
5	Rear Swingarm	90R10GV0277A9	90R10GV0271A5	90R10GV0266A5	90R10GV0258A3	90R10GV0253A7	90R10GV0282A9	90R10GV0088A1	90R10GV0083A7
5	ADV SL FR Swingarm	90R10GVR011A7					90R10GVR006A7		

Dia #	Description	Trance X 3	Trance X 4	Reign 0	Reign 1	Reign 2	Reign X 0	Reign X 1	Reign X 2
1	Upper Rocker Arm	1280GS834001G0	1280GS834001F1	1280GS034A01C8	1280GS034A01D6	1280GS034A01D6	1280GS034B01A7	1280GS034B01A7	1280GS034B01A7
2	Lower Ulink	1280GS834004G1	1280GS834004F1	1280GS034A04C1	1280GS034A04A3	1280GS034A04A3	1280GS034B02A4	1280GS034B02A4	1280GS034B02A4
3	Upper bolt/bearing kit	1280GS834003A4	1280GS834003A4	1280GS034A03A6	1280GS034A03A6	1280GS034A03A6	1280GS034B10A6	1280GS034B10A6	1280GS034B10A6
4	Lower bolt/bearing kit	1280GS834006A6	1280GS834006A6	1280GS034A06A8	1280GS034A06A8	1280GS034A06A8	1280GS034B12A0	1280GS034B12A0	1280GS034B12A0
5	Rear Swingarm	90R10GV0078A7	90R10GV0073A2	90R10GV0103A1	90R10GV0098A8	90R10GV0093A1	90R10GV0122A5	90R10GV0113A6	90R10GV0108A6
7	Rear Shock		12809GU0003A4						

Dia #	Description	Reign SX	Faith 0	Faith 1	Glory 0	Glory 1	Anthem X1 W	Cypher 1	Cypher 2
1	Upper Rocker Arm	1280GS034B01A7	1280GS014A01A4	1280GS014A01B2	1280GS024501A1	1280GS024501B8	1280GS804M01G1	1280GS834001J1	1280GS834004H1
2	Lower Ulink	1280GS034B02A4	1280GS014A02A1	1280GS014A02B1	1280GS024502A7	1280GS024502A7	1280GS804M02G9	1280GS834004J1	1280GS834004J1
3	Upper bolt/bearing kit	1280GS034B10A6	1280GS014A09A2	1280GS014A09A2	1280GS024509A8	1280GS024509A8	1280GS804M10A1	1280GS834003A4	1280GS834003A4
4	Lower bolt/bearing kit	1280GS034B12A0	1280GS014A11A0	1280GS014A11A0	1280GS024511A6	1280GS024511A6	1280GS804M12A6	1280GS834006A6	1280GS834006A6
5	Rear Swingarm	90R10GV0118A2	90R10GV0130A7	90R10GV0126A4	90R10GV0138A5	90R10GV0134A6	90R10GV0263A3	90R10GV0070A7	90R10GV0067A3

## MODEL YEAR 2009

Dia #	Description	Anthem ADV **	Anthem X 0	Anthem X 1	Anthem X 2	Anthem X 3	Trance X 0	Trance X 1	Trance X 2	Trance X 3
1	Upper Rocker Arm	12808GU0015A8	1280GS804M01A2	1280GS804M01C9	1280GS804M01B0	1280GS804M01B0	1280GS834001A1	1280GS834001A1	1280GS834001A1	1280GS834001A1
2	Lower Ulink	12808GU0018B8	1280GS804M02A1	1280GS804M02C6	1280GS804M02B8	1280GS804M02B8	1280GS834004A1	1280GS834004A1	1280GS834004A1	1280GS834004A1
3	Upper bolt/bearing kit	12807GU0017A5	1280GS804M10A1	1280GS804M10A1	1280GS804M10A1	1280GS804M10A1	1280GS834003A4	1280GS834003A4	1280GS834003A4	1280GS834003A4
4	Lower bolt/bearing kit	12807GU0020A0	1280GS804M12A6	1280GS804M12A6	1280GS804M12A6	1280GS804M12A6	1280GS834006A6	1280GS834006A6	1280GS834006A6	1280GS834006A6
5	Rear Swingarm	90R09GV0102A1	90R09GV0097A1	90R09GV0092A3	90R09GV0084A1	90R09GV0079A1	90R09GV0103A5	90R09GV0125A6	90R09GV0120A1	90R09GV0115A1
6	Shock Bolt Kit	12807GU0021A8								

Dia #	Description	Trance X 4	Reign 0	Reign 1	Reign 2	Reign X 0 *	Reign X 1 *	Reign X 2 *	Glory DH *	Glory 0 *
1	Upper Rocker Arm	1280GS834001A1	1280GS034A01A1	1280GS034A01B1	1280GS034A01A1	1280GS034601A9	1280GS034601A9	1280GS034601A9	1280GS024402A1	1280GS014901C4
2	Lower Ulink	1280GS834004A1	1280GS034A04A3	1280GS034A04B1	1280GS034A04A3	1280GS034602A6	1280GS034602A6	1280GS034602A6	1280GS024401A4	1280GS014902A5
3	Upper bolt/bearing kit	1280GS834003A4	1280GS034A03A6	1280GS034A03A6	1280GS034A03A6	1280GS034610A8	1280GS034610A8	1280GS034610A8	1280GS014910A7	1280GS014910A7
4	Lower bolt/bearing kit	1280GS834006A6	1280GS034A06A8	1280GS034A06A8	1280GS034A06A8	1280GS034612A2	1280GS034612A2	1280GS034612A2	1280GS014912A1	1280GS014912A1
5	Rear Swingarm	90R09GV0110A3	90R09GV0145A9	90R09GV0140A2	90R09GV0135A2	90R09GV0158A7	90R09GV0154A8	90R09GV0150A9	90R09GV0170A1	90R09GV0166A9
6	Shock Bolt Kit					1280GS034603A3	1280GS034603A3	1280GS034603A3	12806GU0060A9	1280GS014903A2
7	Rear Shock	12809GU0003A4								
8	Shock cover					12807GU0027A1	12807GU0027A1	12807GU0027A1	12807GU0025A7	No Stock

Dia #	Description	Glory 1 *	Anthem X1 W	Cypher
1	Upper Rocker Arm	1280GS014901D2	1280GS804M01C9	1280GS834001D6
2	Lower Ulink	1280GS014902A5	1280GS804M02C6	1280GS834004D8
3	Upper bolt/bearing kit	1280GS014910A7	1280GS804M10A1	1280GS834003A4
4	Lower bolt/bearing kit	1280GS014912A1	1280GS804M12A6	1280GS834006A6
5	Rear Swingarm	90R09GV0162A1	90R09GV0089A8	90R09GV0107A8
6	Shock Bolt Kit	1280GS014903A2		
8	Shock cover	No Stock		



DESIGN & LAYOUT BY SARAH SANGSTER

# STAFF

## GIANT BICYCLE CANADA, INC.

Unit 100-2255 Dollarton Highway, North Vancouver, BC V7H 3B1  
Toll Free: 800.665.9311 Toll Free Fax: 800.665.1713 Web: giant-bicycles.com

### HEAD OFFICE SALES SUPPORT STAFF



**PAUL NASH**  
DEPUTY GENERAL MANAGER  
paulnash@giantbicycle.com



**SEAN KERR**  
PRODUCT MANAGER  
seankerr@giantbicycle.com



**ANDREW HEWAT**  
GEAR BUSINESS SUPERVISOR  
andrewhewat@giantbicycle.com



**CHERY LIN**  
POS CONTROLLER - BIKE & GEAR  
cherylin@giantbicycle.com



**HUGO LANTHIER**  
AFTER SERVICE/QUALITY ASSURANCE  
hugolanthier@giantbicycle.com



**NICA NOVLESKY**  
EVENT COORDINATOR  
PUBLIC RELATIONS  
LIV REPRESENTATIVE  
nicanovlesky@giantbicycle.com



**STACEY COOK**  
INSIDE SALES -  
BRITISH COLUMBIA & ONTARIO  
staceycook@giantbicycle.com



**LILLIAN TSENG**  
FINANCE & ADMIN SUPERVISOR  
lilliantseng@giantbicycle.com



**JAMES HEALEY**  
INSIDE SALES -  
PRAIRIES, QUEBEC & MARITIMES  
jameshealey@giantbicycle.com



**STELLA CHAN**  
ACCOUNTANT  
stellachan@giantbicycle.com



**STEVE DEVANTIER**  
GRP SPECIALIST  
stevedevantier@giantbicycle.com



**RICH MACHHEIN**  
WAREHOUSE SUPERVISOR  
richmachhein@giantbicycle.com



**SARAH SANGSTER**  
MEDIA DESIGNER  
sarahsangster@giantbicycle.com

### NATIONAL SALES FORCE



**MIKE MILLAR**  
NATIONAL SALES MANAGER /  
TERRITORY MANAGER - ONTARIO  
mikemillar@giantbicycle.com



**GUY PELLERIN**  
TERRITORY MANAGER - MARITIMES  
guypellerin@giantbicycle.com



**COLBY LARGE**  
TERRITORY MANAGER - BC  
colbylarge@giantbicycle.com



**IAN HIGHWAY**  
TERRITORY MANAGER - QUEBEC  
ianhighway@giantbicycle.com



**DEAN KENDELL**  
TERRITORY MANAGER - AB & PRAIRIES  
deankendell@giantbicycle.com



**LUKE KITZANUK**  
STORE MANAGER - VAUDREUIL  
lukekitzanuk@giantbicycle.com



**PHIL LEMAISTRE**  
HEAD MECHANIC - VAUDREUIL  
phillemaistre@giantbicycle.com



**Liv**

[liv-cycling.com](http://liv-cycling.com)

**GIANT**

[giant-bicycles.com](http://giant-bicycles.com)